

Home Safety Self-Assessment Tool



HOME SAFETY SELF ASSESSMENT TOOL (HSSAT) v.4

Falls are the leading cause of injury, disability, nursing home placement, and death in adults over the age of 65 years. Yet in the United States, one in every three older adults falls each year. In order to address this problem, the Occupational Therapy Geriatric Group at the University at Buffalo created the Home Safety Self Assessment Tool, as a combined effort with the Health Foundation for Western and Central New York, to disseminate information regarding how to prevent falls in Erie County. The HSSAT has been found to be useful in reducing the occurrence of falls at home through a study that was conducted at the Department of Rehabilitation, University at Buffalo. In Version 4, “How to” Home Improvement Instructions, with before and after photos, were added to the existing Home Safety Check Lists and Solutions (V. 3). Use of this tool, as instructed in this book, helps to prevent future falls. An online version is available at www.agingresearch.buffalo.edu for download.

The HSSAT (V.4) consists of seven major sections:

1. **The Home Safety Self Assessment Checklist and Solutions**

Information on how to use this section can be found on page 3 of this manual.

2. **Assistive Devices and Helpful Products to Prevent Falls**

The products were selected based on their usability, quality, and rating by users.

The products are categorized to correspond to the Solutions on the Home Safety Checklist.

Picture credits for selected are listed at the end of the Checklist on pages 31-32.

3. **Home Modification Services, Stores Carrying Durable Medical Equipment, and Organizations to Provide Free Services in Erie County**

This section lists service providers in Erie County who perform home modifications such as installing grab bars and railings or widening the doorway of a bathroom. These services providers responded to our request to develop this list. They are insured and have experience in home modifications and remodeling and are willing to perform a small job at your home.

Also listed are the stores that carry durable medical equipment and other products that are useful in preventing falls. Some stores do not have wheelchairs. Free services related to fall prevention in Erie County are also listed in this section. (Pages 41-46)

4. **“How to” Home Improvement Instructions**

Eight pages of steps to take for some common home improvements with before and after photos. (Pages 33 - 40)

5. **Tips for fall prevention**

This one page list includes tips for fall prevention other than the risk factors discussed in the previous sections. (Page 41)

6. **ADA Instructions for Home Environment**

The Americans with Disabilities Act (ADA) sets guidelines for accessibility to public places and commercial facilities by individuals with disabilities. This is not applicable to single homes but may be applicable for commercial apartments. In this section, six guidelines are selected. (Pages 47-53)

7. **Action Log**

This section is provided to keep a record of the home hazard removal process. (Pages 54-55)

Machiko R. Tomita, Ph.D.
September 1, 2013

Department of Rehabilitation Science
University at Buffalo, State University of New York

TABLE OF CONTENTS

| | |
|---|--------------|
| <u>Instructions for How to Use HSSAT Checklist</u> | 3 |
| <u>Home Safety Checklist and Solutions</u> | |
| <u>Area 1: Entrance to Front Door and Front Yard</u> | 4-5 |
| <u>Area 2: Entrance to Back/Side Door</u> | 6-7 |
| <u>Area 3: Hallway or Foyer</u> | 8-9 |
| <u>Area 4: Living Room</u> | 10-11 |
| <u>Area 5: Kitchen</u> | 12-13 |
| <u>Area 6: Bedroom</u> | 14-15 |
| <u>Area 7: Bathroom</u> | 16-17 |
| <u>Area 8: Staircases</u> | 18-19 |
| <u>Area 9: Laundry Room/Basement</u> | 20-21 |
| <u>Assistive Devices and Helpful Products to Prevent Falls</u> | 22-29 |
| <u>Total Number of Home Hazards</u> | 30 |
| <u>Picture Credits for Assistive Devices and Helpful Products</u> | 31-32 |
| <u>“How To” Home Improvement Instructions</u> | 33-40 |
| <u>Tips for Fall Prevention</u> | 41 |
| <u>Home Improvement Centers and Durable Medical Equipment Providers in Erie County</u> | 42 |
| <u>Home Modification Service Providers in Erie County</u> | 43-44 |
| <u>Organizations That Provide Free Services in Erie County</u> | 45-46 |
| <u>Instruction for Home Modifications to Prevent Falls: ADA Guideline</u> | 47-53 |
| <u>Action Log</u> | 54-55 |
| <u>Acknowledgement and Contact Information</u> | 56 |

HOW TO USE HSSAT CHECKLIST TO IDENTIFY HOME HAZARDS TO PREVENT FALLS

Use the checklist to find and correct/fix the hazards for every room/area in your home that might cause you to trip or fall. All items are potential risks for falls but if a wheelchair is not used, some items may not apply.

Steps to use the checklist

Step 1:

Go to each room/area of your home with this checklist; look for the hazards/items that are listed below the picture on each page (Some items may not relate to your home).

Step 2:

If the problem is present in your room/area, check off the appropriate box. After checking all the problems, add them and write the total in the big box (Each item that gets a checkmark is a potential hazard).

Step 3:

Then go through the solutions and take the necessary action to fix those problems that are a potential hazard. Make sure that you look at assistive devices and helpful products that are indicated in the solutions section. Having them can make your home safer.

Step 4:

Add the total number of hazards in all the rooms/areas to get a grand total.

Step 5:

Write down what actions you are planning to take or have already taken to prevent falls in the Action Log for your records.

Step 6:

It may be a good idea to ask your family and friends for a home safety modification or an assistive device for your birthday or holiday present. Also, talk with your friends about home safety. It can be a great gift for them to know how to prevent future falls.

Entrance to Front Door and Front Yard

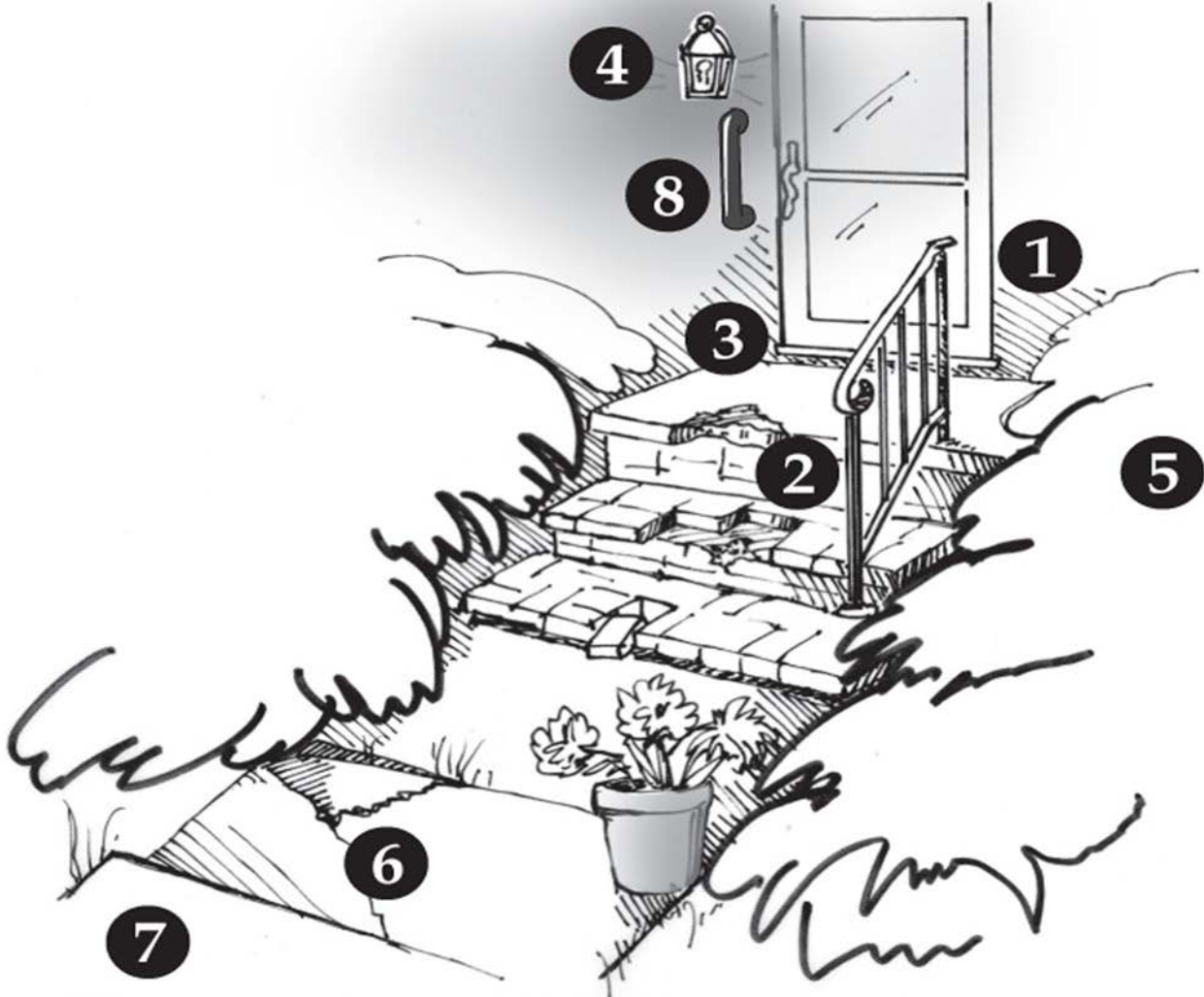

The list identifies all the potential home hazards that may cause a fall. If the item applies to your home place a check in the box. Then add the total number of checks and enter it in the box below.

1. Lack of railings or unstable railing

5. Lack of a ramp for a wheelchair

2. Unsafe steps (too steep/cracked)

6. Uneven/cracked pavement

3. Unmarked or raised threshold

7. Ice or snow on driveway/walkway

4. Lack of lighting at night

8. Lack of an outdoor grab bar

Other _____

Total number of problems

* The numbers correspond to the hazard in the picture and solutions on the following page

Solutions for the Problems in Entrance to Front Door and Front Yard

1. Lack of railings or unstable railing

Add at least one railing, ideally one on each wall. **(See page 22, item 1)**
Have unstable railing stabilized.

2. Unsafe steps (too steep, cracked, chipped, etc.)

Have damaged or broken steps repaired.

3. Unmarked or raised threshold

Mark end of steps or thresholds with contrasting tape or paint color to increase awareness of changes in height. **(See page 22, item 2)**

4. Lack of lighting at night

Add an outdoor light fixture if not present.
Add a sensor light that automatically turns on and off. **(See page 22, item 3)**

5. Lack of a ramp for a wheelchair

Have a remodeler or home contractor construct a ramp that will allow wheelchair access in and out of the home. **(See page 23, item 4)**

6. Unsafe pavement (uneven or cracked)

Have uneven or cracked pavement repaired.
Avoid these areas if possible when walking to and from the home.
You may contact local government for repair if it is a sidewalk or driveway end.

7. Ice or snow on driveway or walkway

Use snow melter.
Have snow/ice removed by a neighbor or service. **(See page 23, item 5)**

8. Lack of an outdoor grab bar

Add an outdoor grab bar next to the door. **(See page 23, item 6 & page 33, item 1)**

For information on additional devices, see page 29, item 31.

Entrance to Back/Side Door

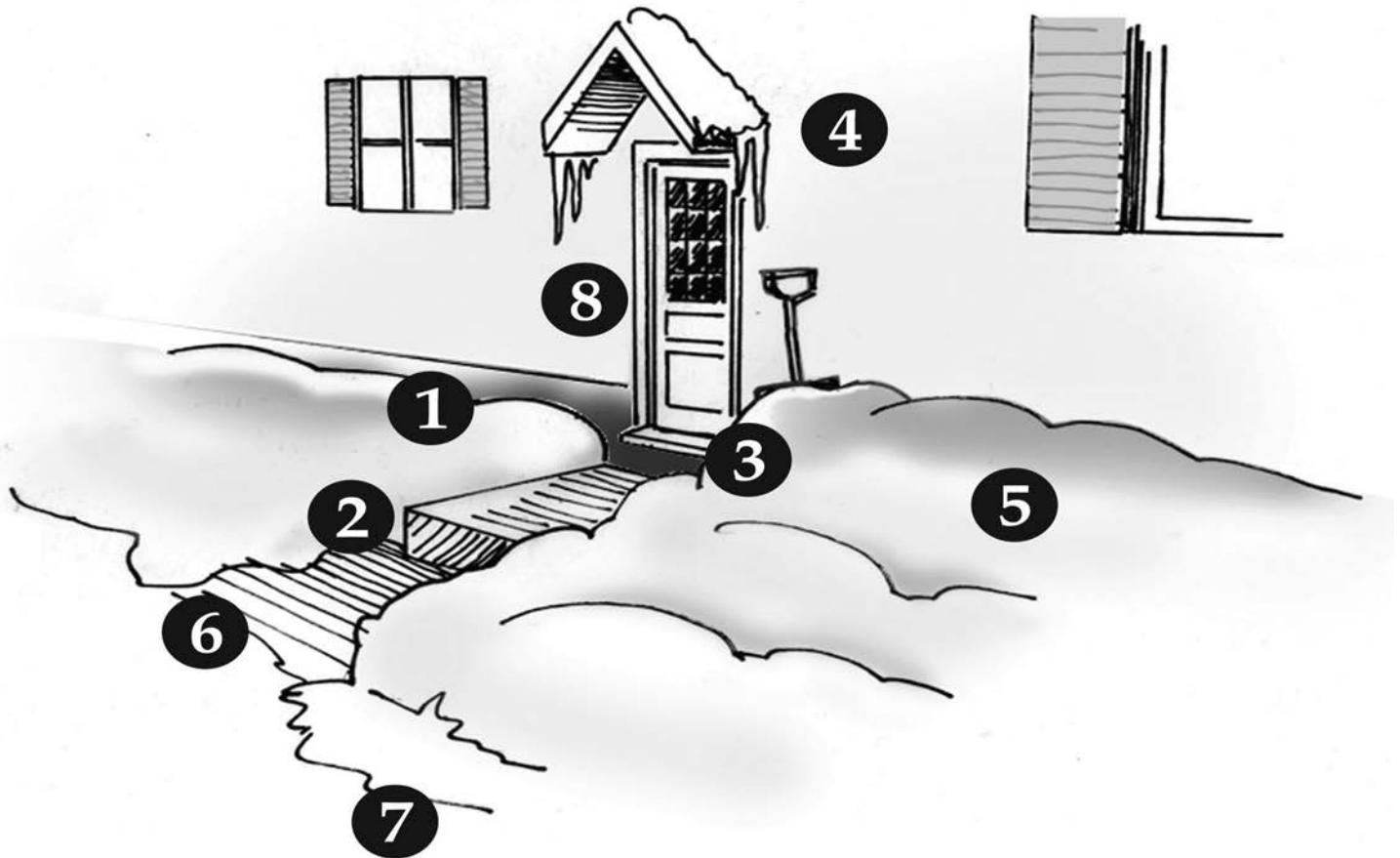

The list identifies all the potential home hazards that may cause a fall. If the item applies to your home place a check in the box. Then add the total number of checks and enter it in the box below

- | | |
|---|---|
| <input type="checkbox"/> 1. Lack of railings or unstable railing <input type="checkbox"/> 2. Unsafe steps (too steep/cracked/chipped) <input type="checkbox"/> 3. Unmarked or raised threshold <input type="checkbox"/> 4. Lack of lighting at night | <input type="checkbox"/> 5. Lack of a ramp for a wheelchair <input type="checkbox"/> 6. Uneven/cracked pavement <input type="checkbox"/> 7. Ice or snow walkway <input type="checkbox"/> 8. Lack of a outdoor grab bar |
|---|---|

Other _____

Total number of problems

* The numbers correspond to the hazard in the picture and solutions on the following page

Solutions for the Problems **Entrance to Back/Side Door**

1. Lack of railings or unstable railing

Add at least one railing, ideally one on each wall. **(See page 22, item 1)**
Have unstable railing stabilized.

2. Unsafe steps (too steep, cracked, chipped, etc.)

Have damaged or broken steps repaired.

3. Unmarked or raised threshold

Mark end of steps or thresholds with contrasting tape or paint color to increase awareness of changes in height. **(See page 22, item 2)**

4. Lack of lighting at night

Add an outdoor light fixture if not present.
Add a sensor light that automatically turns on and off. **(See page 22, item 3)**

5. Lack of a ramp for a wheelchair

Have a remodeler or home contractor construct a ramp that will allow wheelchair access in and out of the home. **(See page 23, item 4)**

6. Unsafe pavement (uneven or cracked)

Have uneven or cracked pavement repaired.
Avoid these areas if possible when walking to and from the home.
Contact local government for repair if it is a sidewalk or driveway end.

7. Ice or snow on walkway

Use snow melter.
Have snow/ice removed by a neighbor or service. **(See page 23, item 5)**

8. Lack of an outdoor grab bar

Add grab bar next to the door. **(See page 23, item 6)**

Hallway or Foyer

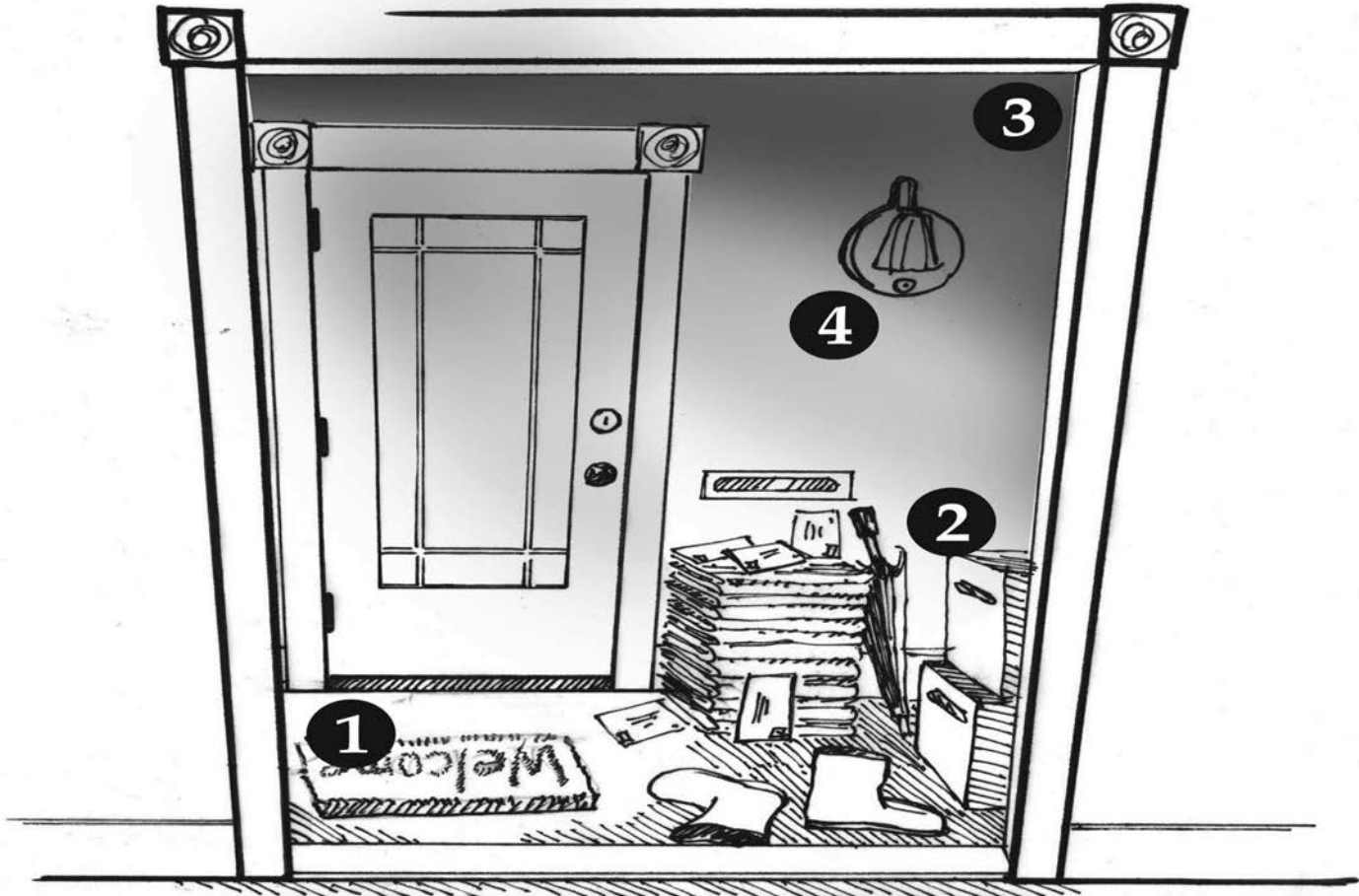

The list identifies all the potential home hazards that may cause a fall. If the item applies to your home place a check in the box. Then add the total number of checks and enter it in the box below.

1. Uneven or slippery flooring

3. Dark or poor lighting

2. Cluttered area

4. Lack of access to ceiling light

Other _____

Total number of problems

* The numbers correspond to the hazard in the picture and solutions on the following page

Solutions for the Problems **in Hallway or Foyer**

1. Unsafe flooring (slippery, uneven carpeting, etc.)

Make sure floor surfaces are dry.

If you have a carpet, make sure that the patterns are not too busy.

Have carpet stretched or removed to eliminate wrinkles or bumps.

Add a carpet runner to slippery hallways or foyers and secure to the floor.

(See page 26, item 17)

2. Cluttered area

Eliminate clutter on floors by removing and/or organizing items.

Example: shoe tray, hooks for umbrella.

3. Dark or poor lighting

Increase wattage to allowable limits in lights.

Add additional overhead or wall lighting.

4. Lack of access to ceiling light

Ask another person to change the light.

Add removable wall lights to poorly lit areas. **(See page 23, item 7)**

Living Room

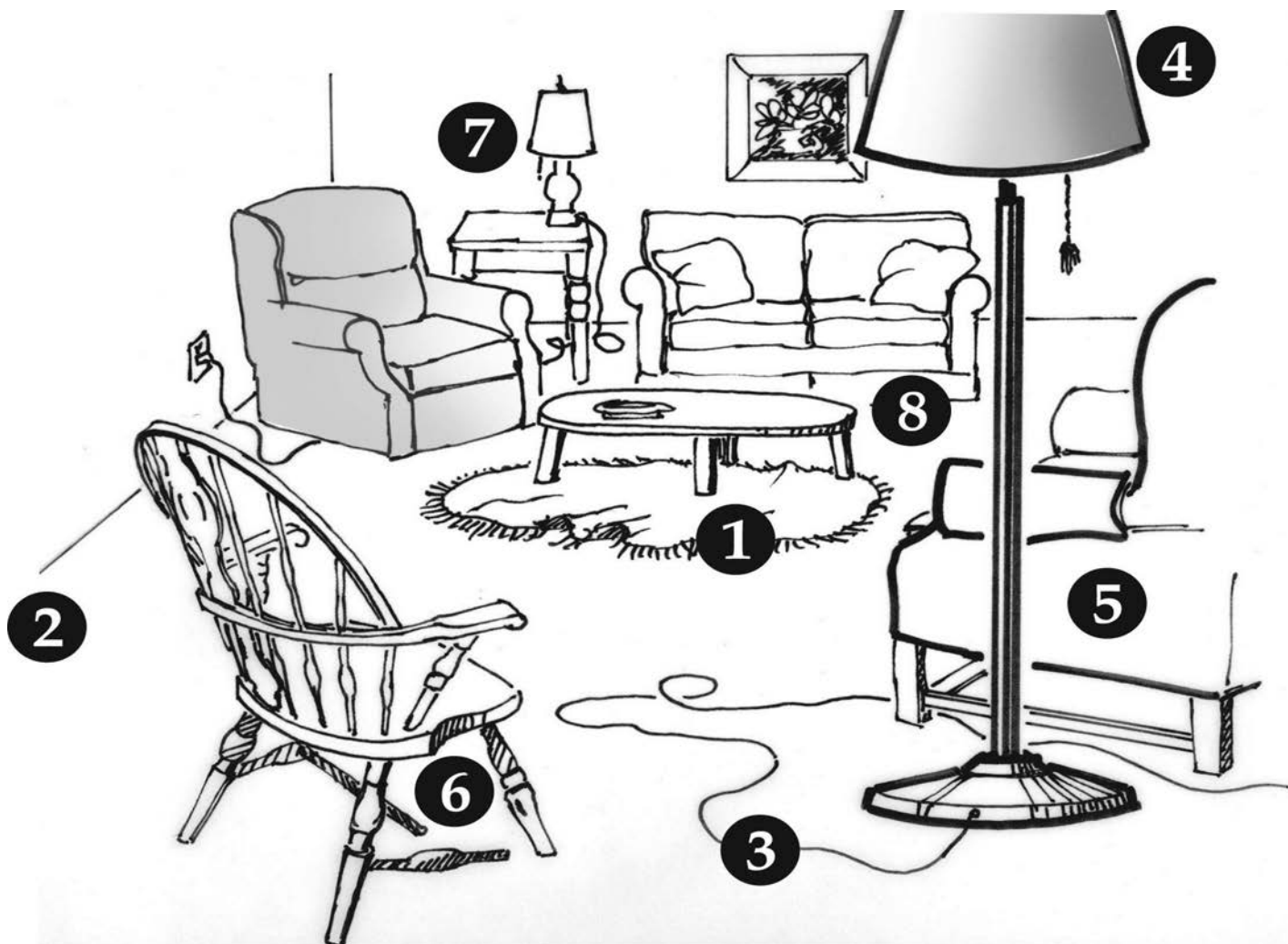

The list identifies all the potential home hazards that may cause a fall. If the item applies to your home place a check in the box. Then add the total number of checks and enter it in the box below.

1. Presence of throw or scatter rug

5. Presence of unstable furniture

2. Presence of clutter

6. Presence of unstable chair

3. Presence of electric cords across the floor

7. Difficult to access light switches

4. Poor lighting

8. Not enough space to move around

Other _____

Total number of problems

* The numbers correspond to the hazard in the picture and solutions on the following page.

Solutions for the Problems in Living Room

1. Presence of throw or scatter rug (See page 24, item 8)

Remove a scatter rug or use a double sided rug tape or a rug pad to secure the rug to the floor.

2. Presence of clutter

Eliminate clutter on floor surfaces by placing items on shelves or storage. Consider donating or throwing out the items you no longer use. Avoid carpets with confusing patterns.

3. Presence of electric cords across the floor

Run your cords behind furnishings. Use extension cords to accomplish this. Rearrange items that must be plugged in to areas near an outlet. **(See page 24, item 9 & page 36, item 7)**

4. Poor lighting

Increase wattage to allowable limits in lamps/lights. Add additional lamps or wall/overhead lights. **(See page 34, item 4)**

5. Presence of unstable furniture (chair, table, etc.)

Place a block under the shorter leg. If the chair or table is broken, have it repaired or replaced.

6. Presence of unsafe chair (too low, too high, without arms)

If the chair is too low, add a furniture leg riser to raise the height. A chair that is too high or without arms should not be used, as it will not provide you with sufficient stability to get in and out of the chair. **(See page 24, item 10)**

7. Difficult to access light switches

Add "clapper" light switch control to lamps. There are other remote control switching options for operating the lights. Rearrange furnishings to allow quick access to wall switch or lamps.

8. Not enough space to move around

Remove clutter or excess furniture that prevent you from moving around the room easily. Some items may be rearranged, but you may want to donate or throw out other items you don't really need or use.

For information on additional device, see page 24, item 11

Kitchen

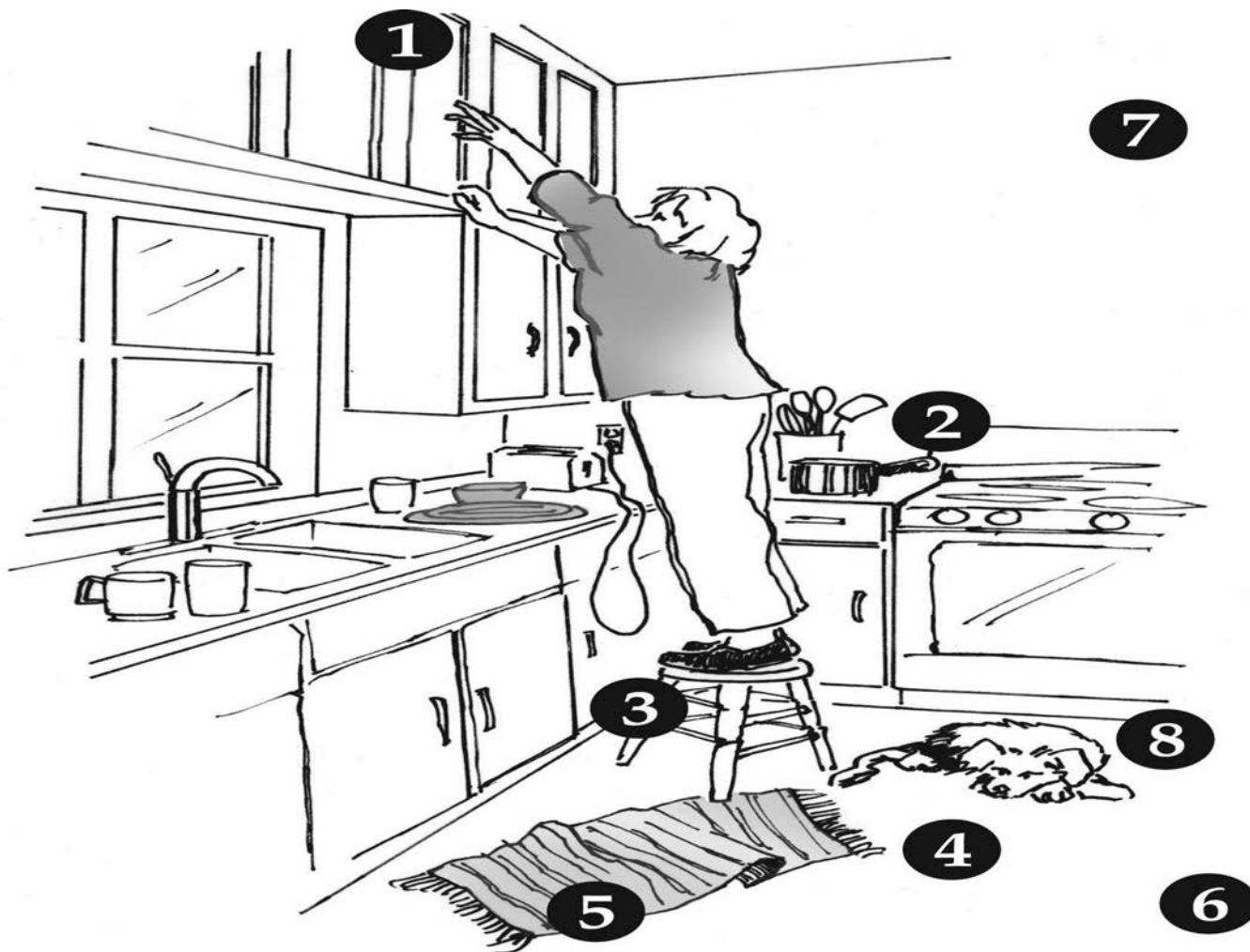

The list identifies all the potential home hazards that may cause a fall. If the item applies to your home place a check in the box. Then add the total number of checks and enter it in the box below

- | | |
|--|---|
| <input type="checkbox"/> 1. Cabinet too high or low <input type="checkbox"/> 2. Not enough counter space <input type="checkbox"/> 3. Using a stool or a chair to reach things <input type="checkbox"/> 4. Not enough room to maneuver | <input type="checkbox"/> 5. Presence of throw/ scatter rug <input type="checkbox"/> 6. Presence of slippery floor <input type="checkbox"/> 7. Poor lighting <input type="checkbox"/> 8. Presence of a pet underfoot when preparing meals |
|--|---|

Other _____

Total number of problems

* The numbers correspond to the hazard in the picture and solutions on the following page

Solutions for the Problems in Kitchen

1. Cabinet too high or too low

Move items to the shelves closest to the counter.
Add hooks to the wall for pots and pans you use frequently.

2. Not enough counter space

Make sure available counter space is cleared of clutter. Use Lazy Susan.
(See page 25, item 14)
Move kitchen table closer to counter for additional work space.
Use a rolling cart for added work space.

3. Using a stool to a chair to reach things

Move items to lower shelves.
Replace the stool with a sturdy step ladder. **(See page 25, item 12)**

4. Not enough room to maneuver

Eliminate clutter or excessive furniture (extra kitchen chairs, etc.) to add space.
Remove a leaf from the table and push it closer to the wall.

5. Presence of a throw/scatter rug

Remove a scatter rug or use a double sided rug tape or a rug pad to secure the rug to the floor. **(See page 24, item 8)**

6. Presence of slippery floor

Do not walk on a wet floor.
Wear comfortable and fit shoes or socks with a non-skid sole.
(See page 25, item 13)
Change flooring surface to one that is less slippery.

7. Poor lighting

Increase wattage of bulbs to allowable level.
Add under counter lighting.
Add additional overhead lighting.

8. Presence of a pet underfoot when preparing meals

Remove the pet from the kitchen while cooking and add a pet gate to the entry ways of the kitchen. **(See page 25, item 15)**
Put the pet outside or in a crate.

For information on additional device, See page 26, item 16

Bedroom

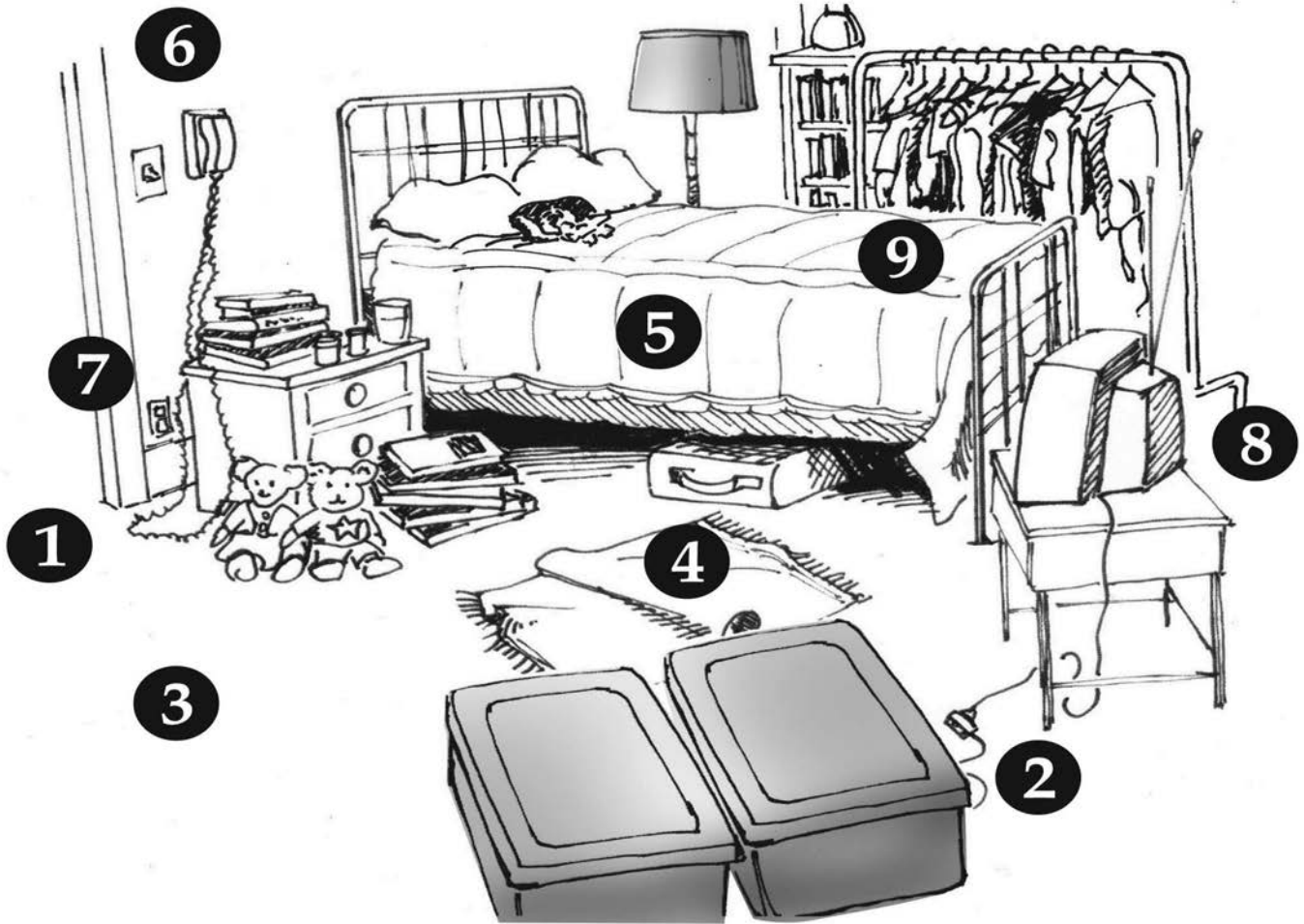

The list identifies all the potential home hazards that may cause a fall. If the item applies to your home place a check in the box. Then add the total number of checks and enter it in the box below

- | | |
|---|---|
| <input type="checkbox"/> 1. Presence of clutter | <input type="checkbox"/> 6. Lack of a telephone near the bed |
| <input type="checkbox"/> 2. Presence of electric cords across the floor | <input type="checkbox"/> 7. Lack of nightlight |
| <input type="checkbox"/> 3. Unsafe carpet (uneven, torn, curled up) | <input type="checkbox"/> 8. Arrangement that causes difficulty to reach items (TV remote, lamp) |
| <input type="checkbox"/> 4. Presence of throw/scatter rug | <input type="checkbox"/> 9. Lack of device to get in/out of bed |
| <input type="checkbox"/> 5. Height of bed (too low/high) | |

Other _____

Total number of problems

* The numbers correspond to the hazard in the picture and solutions on the following page

Solutions for the Problems In Bedroom

1. Presence of clutter

Eliminate clutter on floor surfaces by placing items on shelves or storage. Consider donating or throwing out the items you no longer use.

2. Presence of electric cords across the floor (See page 24, item 9)

Run your cords behind furnishings. Use extension cords to accomplish this. Rearrange items that must be plugged in to areas near an outlet.

3. Unsafe carpet (uneven, torn, curled up, etc.) (See page 26, item 17)

Have carpet stretched or removed to eliminate wrinkles or bumps.

4. Presence of throw/scatter rug (See page 24, item 8)

Remove all scatter and throw rugs or use a double sided rug tape or a rug pad to secure the rug to the floor.

5. Height of bed (too high or low) (See page 24, item 10)

Too low (your knees are above the hips when sitting at the edge of the bed) : Use bed risers below bed legs to raise height.

Too high (your legs do not touch the floor when sitting at the edge of the bed): Remove bed frame or use a lower profile mattress or box spring.

6. Lack of a telephone near the bed (See page 26, item 18)

Place a cordless type or cell phone next to your bed at night or during naps. Use a remote control for TV and VCR. (See page 26, item 19)

7. Lack of a nightlight (See page 23, item 7)

Place at least two nightlights in the bedroom to illuminate the room at night. Add additional nightlights along the hall or path to the bathroom. Also add one nightlight in the bathroom.

8. Arrangement that causes difficulty to reach commonly used items such as a TV remote, medications, lamp, glasses, magnifier, etc. at night

Place these items on your bedside table. If you don't have a table, you may put a rolling cart or shelving unit next to the bed.

9. Lack of a device to help get in and out the bed (See page 27, item 20)

Purchase a half bedrail or a bed cane that can slide between mattress and box spring.

Bathroom

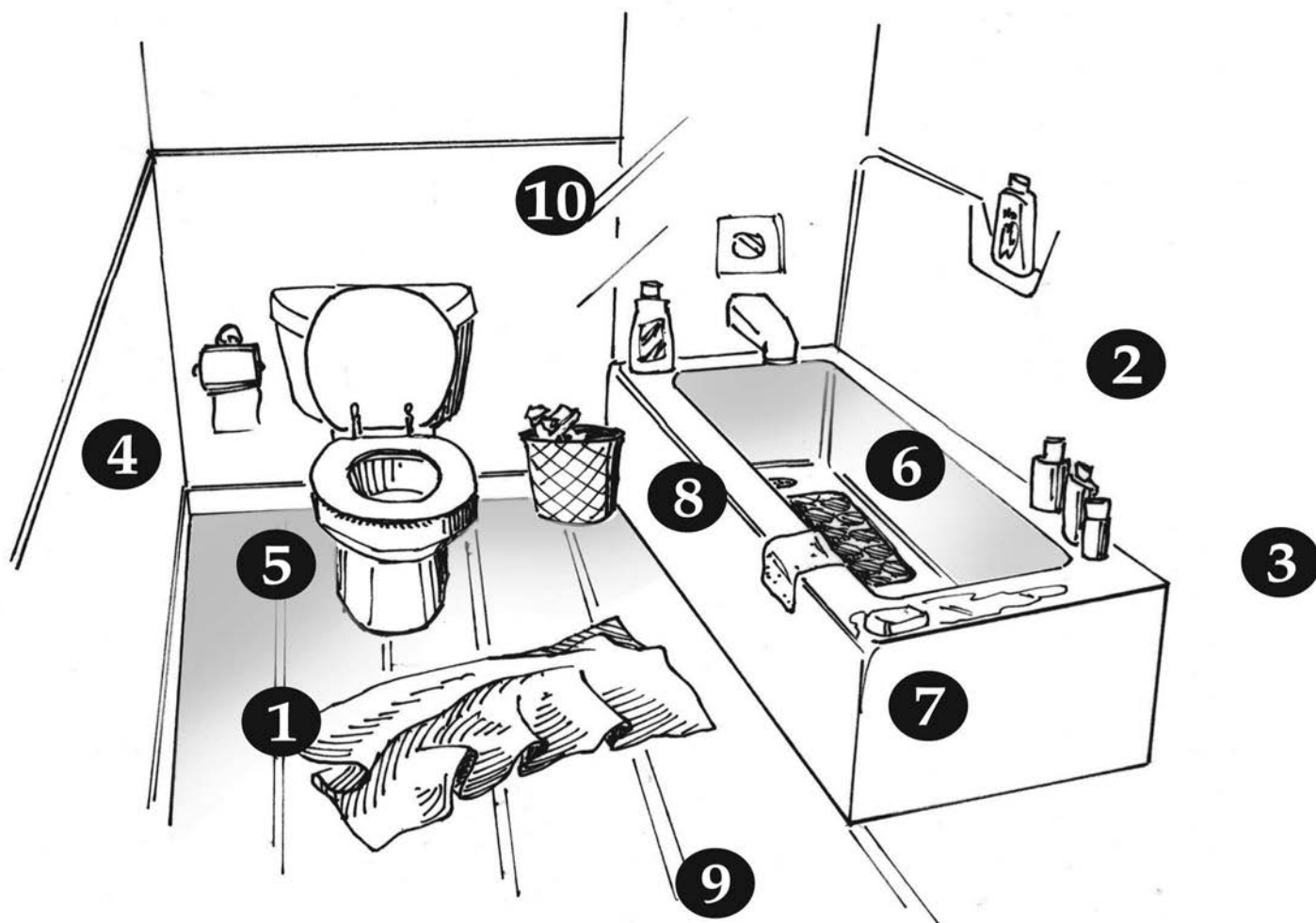

The list identifies all the potential home hazards that may cause a fall. If the item applies to your home place a check in the box. Then add the total number of checks and enter it in the box below

- | | |
|--|--|
| <input type="checkbox"/> 1. Presence of unsafe bath rugs <input type="checkbox"/> 2. Lack of grab bars in the tub <input type="checkbox"/> 3. Lack of grab bars in the shower area <input type="checkbox"/> 4. Lack of grab bars near the toilet <input type="checkbox"/> 5. Toilet is too high or low | <input type="checkbox"/> 6. Slippery tub (lack of bath mat, etc.) <input type="checkbox"/> 7. Claw foot/tub that is high to get into <input type="checkbox"/> 8. Lack of bath chair in the shower area <input type="checkbox"/> 9. Clutter <input type="checkbox"/> 10. Incorrect placement of grab bars |
|--|--|

Other _____

Total number of problems

* The numbers correspond to the hazard in the picture and solutions on the following page

Solutions for the Problems in Bathroom

1. Presence of unsafe bath rugs.

Use a bath rug with non-skid bottom.

2. Lack of grab bars in the tub (See page 27, item 21)

Add a bath grab bar on the wall or a clamp-on grab bar to the tub.

3. Lack of grab bars in the shower area

Add grab bars to the wall near the shower and on the wall where the bath faucets are.

4. Lack of grab bars near the toilet (See page 27, item 22)

Add a grab bar on the wall next to the toilet or toilet safety grab bars that attach at the toilet seat screws.

5. Toilet is too high or too low (See page 27, item 23)

Add a raised toilet seat for seats that are too low.
Consider a lower profile toilet if it is too high.

6. Slippery tub (lack of bath mat, etc.) (See page 28, item 24)

Add a rubber bath mat or adhesive non-skid decals to the bottom of the tub.

7. Claw foot or other type of tub that is too high to get into easily

Add a tub transfer bench to slide into the tub area or replace with a lower tub.

8. Lack of bath chair in the tub or shower area or tub transfer bench

Add a bath chair along with grab bars to the tub or shower area. A tub transfer bench is helpful if you have difficulty stepping into the tub area, because you can sit and slide over into the tub area.

9. Clutter

Remove clutter from all floor areas to drawers or closets. Inexpensive plastic cabinets or rolling units can be purchased to store bath items.

10. Incorrect placement of grab bars

If permanently installed, hire a qualified professional to change the grab bars to the correct location and angle.

*** See page 28, items 25 & 26 and page 29, item 31**

Staircases

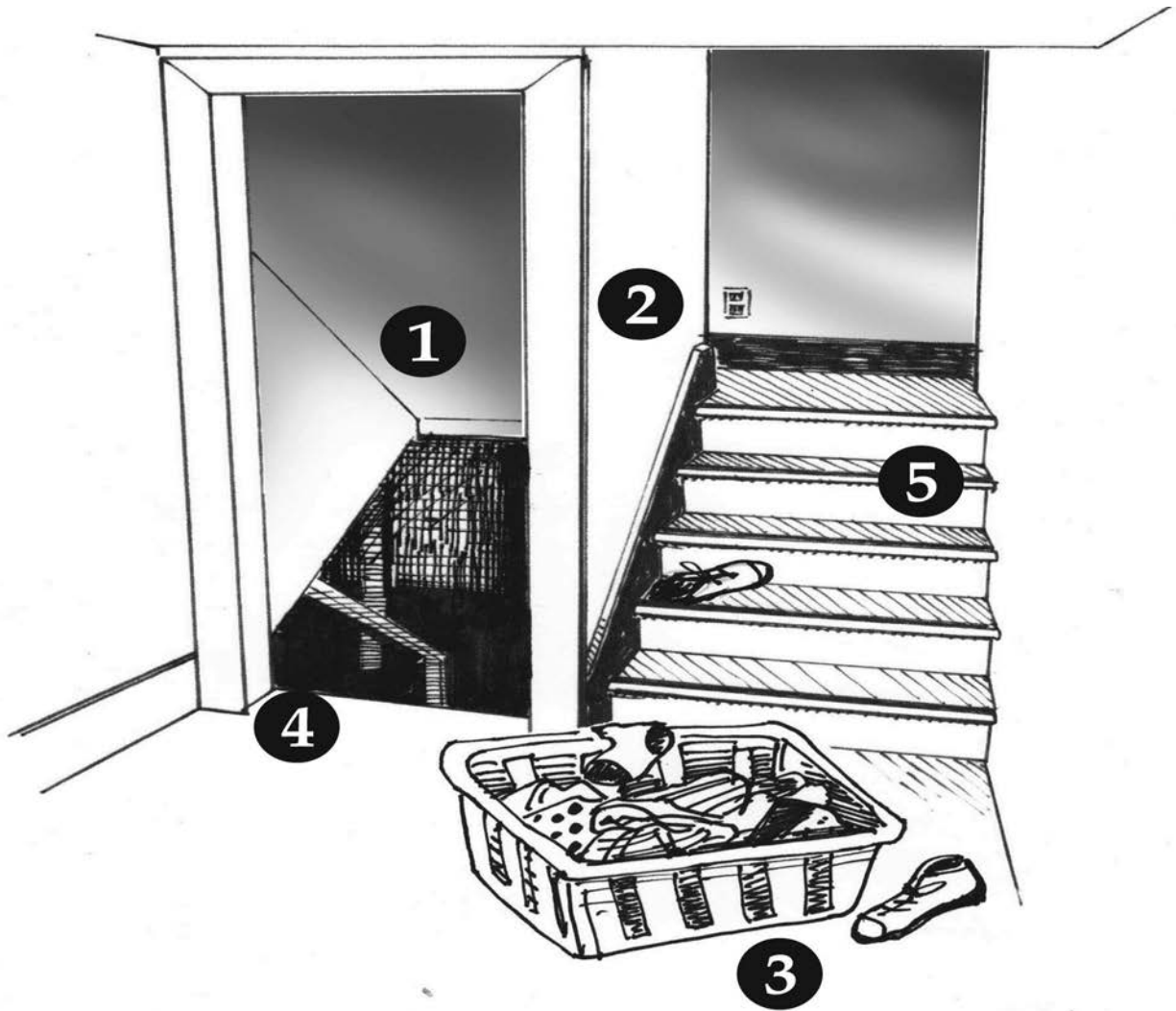

The list identifies all the potential home hazards that may cause a fall. If the item applies to your home place a check in the box. Then add the total number of checks and enter it in the box below

1. Poor or lack of lighting

4. Steps too steep

2. Lack of railings

5. Slippery steps without tread/ carpet

3. Clutter

Other _____

Total number of problems

* The numbers correspond to the hazard in the picture and solutions on the following page.

Solutions for the Problems **in Staircases**

1. Lack of or poor lighting (See page 29, item 30)

Increase wattage to allowable limits in lights.
Add additional overhead or wall lighting.

2. Lack of railings (See page 28 & 29, items 27 & 28, & [age 38, item 11)

Add at least one railing the entire length of the wall, ideally one on each side.

3. Clutter (See page 40, item 16)

Eliminate clutter on floors by removing and/or organizing items in areas near the stairs.

4. Steps too steep

Use railings for stability.
Walk slowly up and down stairs with lights on.
Have others carry heavy or large items up or down the stairs.
Reduce daily use of stairs to reduce risk of falls.

5. Slippery steps without tread or carpet or luminous light (See page 29, items 29 and 30 & page 37, item 9)

Add adhesive stair treads or carpet runner.

Laundry Room/Basement

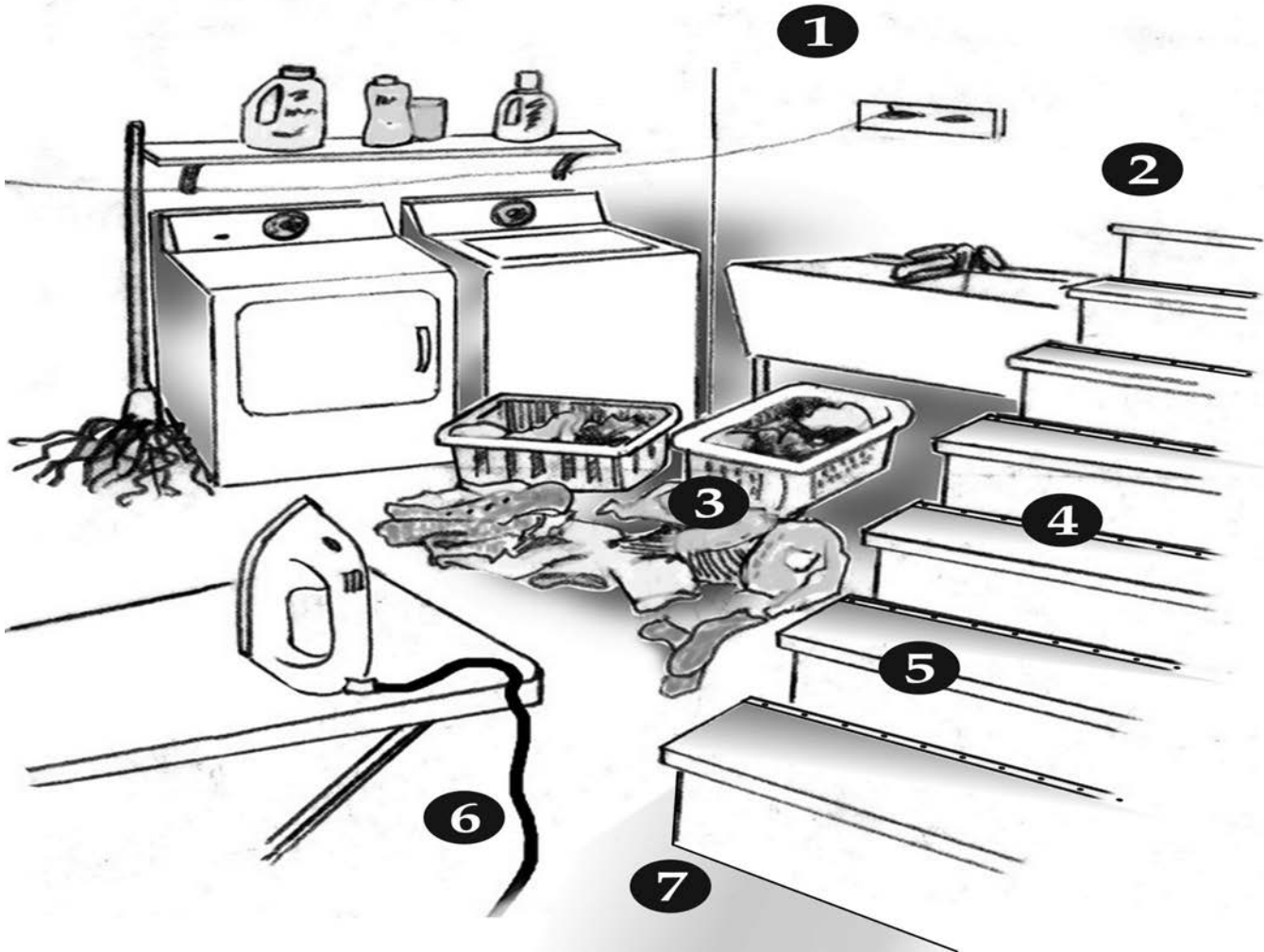

The list identifies all the potential home hazards that may cause a fall. If the item applies to your home place a check in the box. Then add the total number of checks and enter it in the box below

- | | |
|--|---|
| <input type="checkbox"/> 1. Poor or lack of lighting <input type="checkbox"/> 2. Lack of railings <input type="checkbox"/> 3. Clutter <input type="checkbox"/> 4. Steps too steep | <input type="checkbox"/> 5. Slippery steps without carpet /luminous light <input type="checkbox"/> 6. Presence of cords across the floor <input type="checkbox"/> 7. Same colored floor at bottom of stairs |
|--|---|

Other _____

Total number of problems

* The numbers correspond to the hazard in the picture and solutions on the following page

Solutions for the Problems **in Laundry Room**

1. Lack of or poor lighting

Increase wattage to allowable limits in lights.
Add additional overhead or wall lighting.

2. Lack of railings

Add at least one railing the entire length of the wall, ideally one on each side.

3. Clutter

Eliminate clutter on floors by removing and/or organizing items in areas near the stairs.

4. Steps too steep

Use railings for stability.
Walk slowly up and down stairs with lights on.
Have others carry heavy or large items up or down the stairs.
Reduce daily use of stairs to reduce risk of falls.

5. Slippery steps without tread or carpet or luminous light (See page 29, item 30)

Add adhesive stair treads or carpet runner.

6. Presence of cords across the floor (See page 24, item 9)

Run your cords behind furnishings. Use extension cords to accomplish this.
Rearrange items that must be plugged in to areas near an outlet.

7. Same colored floor at bottom of stairs

Have the bottom of the stairs painted a different color so that you are aware of the last step.

Assistive Devices and Helpful Products to Prevent Falls

Disclaimer

The products listed in this section are currently available in the market. We selected these types of products based on our experience and public reviews.

For further information, contact product's manufacturer and distributors. The price ranges listed are as of January, 2013 and are subject to change. For installation of grab bars, railings, and other products contact qualified professionals for installation. The number before the products (such as **1.** for Vinyl railings) coincides with that indicated in the Home Safety Checklist and Solutions section as well as in the Picture Credits.

Entrance to Front and Back

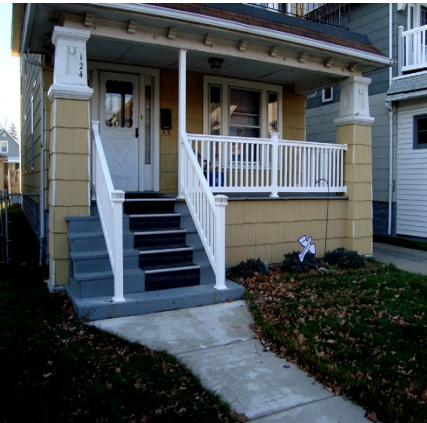

1. Vinyl railing

Hand railings on both sides of the stairs will provide support for safely climbing and descending the stairs. Vinyl railings have advantages over wooden or metallic railings in terms of durability, maintenance costs, corrosion, resistance to mold, and decay.

Price range: Approx. \$68 for 36in X 4ft section

Approx. \$210 for 42in X 8ft section



2. Rubber threshold ramp

Threshold ramps can prevent stumbling and also provide accessibility to the users of a wheelchair or scooter. Rubber threshold ramps have advantages over metallic or wooden ramps in terms of traction, and shock absorption. It can be trimmed to custom fit various doorways. It is available in various sizes. (Note: Threshold ramps may be needed for both sides of a threshold)

Price range: Approx. \$90 for 42”(W) X 24”(L) X 1.5(H)

Approx. \$150 for 42”(W) X 24”(L) X 2.5(H)



3. Motion sensing security lamp

Lights with motion sensors can detect movement within a specified range and then illuminate. The motion sensing security lamp shown in the picture has a manual override feature so that the light turns on in the dark and turns itself off during the day instead of just when there is motion.

Price range: \$35 – \$70



4. Suitcase/Fold ramp

Suitcase or fold ramps are easy to carry and are used to bridge the gap over steps, curbs, and raised landings. To get in and out of mini vans with an end or side entrance, a fold aluminum ramp can be used. This fold aluminum ramp with a non-skid surface shown in the picture has several advantages over wooden and single-piece design ramps because it is corrosion and rust free, has a high traction surface with side rails, and a foldable design for easy transportation.

Price range: \$115 for 2ft ramp
\$279 for 6ft ramp



5. Cane icetip

An ice tip is easily attached to most canes and crutches to provide good grip on an icy surface to prevent falls. The key feature of this attachment shown in the picture is that it has five prongs to provide greater grip than attachments with one prong, and it can be used with any type of cane.

Price range: \$6 - \$29



6. Outdoor grab bar

A grab bar at an entrance provides support and makes it safer and easier to open an entrance door. The key feature of this plastic grab bar shown in the picture is that it is rust proof and in winter, will not get as cold as a metal grab bar. Weight capacity of a recommended grab bar in general is 250 pounds and above.

Price range: \$15 - \$53

Hallway and Living Room

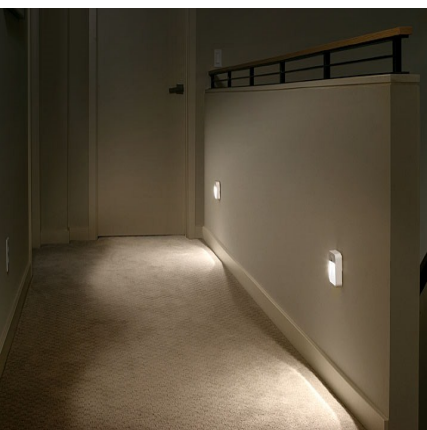

7. Motion sensing LED light

Using automatic LED lights is an efficient way to illuminate dark hallways to prevent falls. The motion sensors activate the light whenever movement is detected, and the auto shut-off feature turns the light off when there is no movement for a preset duration of time. The light in the picture does not require wiring for the installation, and the built-in photocell activates light in a low-glow mode in darkness, thus saving on battery life.

Price range: \$8 - \$40



8. Rug pad and double sided carpet tape

Rug pads can prevent the mats and rugs from skidding over the floor and provides cushioning underfoot. Various pads differ in their dimensions, color, and material. Carpet tape can also be used alone or in combination with a rug pad. The key feature of this rug pad is that it is made from eco-friendly materials.

Price range: \$7 - \$149

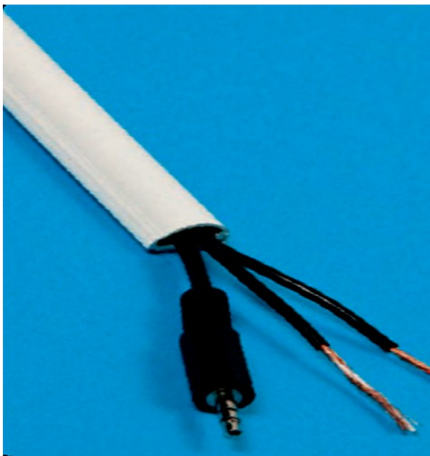

9. Single-piece cable cover

Cable covers keep the wires and cords off the floor and eliminate the risk of falls by getting tangled in them. Cable covers, such as the one shown in the picture, are easy to install because of their single-piece design and self-adhesive backing. They can also be painted to match the color of the interior.

Price range: \$12 - \$34



10. Furniture risers

Risers elevate the height of the bed, chairs, or table if they are too low. They also create considerable space under the bed for storage. The key feature of this furniture leg riser is that it is made of durable polycarbonate with an interlocking design for safe stacking, and it can fit most leg types including castors. The usual weight carrying capacity of a single riser is 600 lbs. per leg.

Price range: \$7 - \$49



11. Standing cane with tray feature

A standing cane provides safety and balance while getting in or out of a chair. There are several key features of this standing cane such as a fully adjustable height and length, and it features a handy multi-use swivel laptop/TV tray with cup holder and utensil compartment.

Price range: \$130 - \$180

Kitchen



12. Three step ladder

A 3-step ladder with a wide platform top is helpful to reach shelves. The ladder shown in the picture has several key features such as a large standing platform for stable and secure use, thin design for saving space, a convenient hand grip with non-skid steps, and non-marring feet for secure footing on the ladder.

Price range: \$28 - \$153



13. Non-slip socks/Safe shoes

Well fit canvas shoes or athletic shoes are recommended. Shoes with more than 1.5 inch heels may cause falls. If shoes are not preferred inside the home then wearing non-slip socks can diminish the risk of falling on bathroom, kitchen, wood and other slippery floors. The key feature of this non-slip sock is that it has skid resistant treads.

Price range: \$2 - \$19 for non-slip socks

\$30 - \$60 for canvas shoes

\$30 - \$70 for athletic shoes



14. Lazy Susan

Lazy Susans can be used to save space and organize items in the kitchen. There are many shapes of Lazy Susans such as full circle, kidney shaped, and d-shaped. They can be a single tray or multi-tier shelves. They can be free standing on a tabletop or installed in a kitchen cabinet. When installing in a cabinet, there should be appropriate clearance from the hinge and the door.

Price range: \$8 - \$44 for single turntable

\$50 - \$300 for 2 tier shelf



15. Hallway security gate

Security gates of different shapes and sizes are available to keep children and pets away from the kitchen, or other restricted areas of the house. Some of the gates swing open in both directions with easy, one hand operation. Some of the gates are tall (39.4 inches) and can expand up to 63.5 inches (Note: When the door is open, there is still a portion of the gate on the bottom that remains in the way. Be careful while stepping over the remaining part of the gate.)

Price range: \$55 - \$124



16. Programmable stove shutdown device

Automatic stove control devices turn off the stove if a person leaves the kitchen unattended and forgets to come back. The key feature of the device in the picture is that it automatically turns the stove off when someone is not present in the kitchen. It has a motion sensor to detect the presence of an individual in kitchen. (Note: Different models available for either 3 or 4 prong stoves).

Price range: \$296 - \$360

Bedroom



17. Carpet trim

Carpet trims are available in different colors and materials such as metal, rubber, wood or plastic. They prevent the carpet edges from fraying and smooth the transition between a floor and a carpet and vice versa. The product shown in the picture has a fluted design for better traction and predrilled holes for easy installation.

Price range: \$4 - \$106 for approximate 2 inches X 72 Inches



18. DECT 6.0 cordless phone

Some of the latest cordless phones offer Digital Enhanced Cordless Telecommunications (DECT) 6.0 technology that provides clearer and louder voice output that can benefit individuals with mild to moderate hearing loss. The key features of this phone are large, high contrast and easy to press numbers, an intercom between handsets, sound amplification up to 30 decibels, digital answering machine, and long battery life. Price range: \$37 - \$192



19. Big button remote control

Remote controls for TVs and VCRs with a small number of buttons are simple to use. The key features of this remote control is that it only has 6 large lighted buttons for the most basic functions and is easy to hold in your hand. Price range: \$14 - \$44



20. Bedside cane/bed rail

Bed side canes/bed rails provide assistance for getting in and out of bed. A long bed rail is not recommended because it can cause injuries. The device shown in the picture has the following features: an ergonomic non-slip handle, adjustable height, foldable design for easy storage and travel, an organizing pouch for essential items such as a remote control or a cordless phone, a collapsible design to get it out of the way when required, and a safety strap for securing the base of the cane to the bed.

Price range: \$40 - \$160

Bathroom



21. Bathtub grab bar

Some grab bars can be mounted on the edge of the bath tub by a clamping mechanism. The turning knob located on the outside of the clamping mechanism is used to secure the grab bar. The key feature of this grab bar is that it is made of plastic and stainless steel. (Note: Do not use with fiberglass bathtubs because it can damage the fiberglass).

Price range: \$22 - \$171



22. Right angled grab bar

Right angled grab bars are used both horizontally and vertically. These grab bars offer a left hand or right hand orientation depending upon the handedness of the user and the placement of the bath tub, shower, or toilet. The grab bar shown in the picture is ADA standards compatible with a non-slip surface. (Note: ADA guidelines say that the clearance between the grab bar and the wall should not be more than 1½ inches).

Price range: \$81 - \$128



23. Raised toilet seat

Raised toilet seats assist people with bending and seating difficulties and in performing toilet transfers with ease. The device shown in the picture has an extra wide toilet seat for bariatric patients, height adjustable aluminum legs, padded armrests, and a 600 pound weight capacity.

Price range: \$13 - \$70 for raised toilet seat without arms

\$30 - \$103 for raised toilet seat with arms

\$75 - \$200 for bariatric raised toilet seat with arms



24. Bath mat

Bath mats will reduce the risk of slipping on a wet bath tub surface. The key features of this mat are the use of antimicrobial materials to prevent any mold and mildew, machine washable, and suction cups on the bottom. (Note: The mat should be removed from the tub, rinsed, and allowed to air dry after each use).

Price range: \$6 - \$69



25. Water alarm with temperature monitor

Water alarm devices send an audible alarm when the water reaches the base of the unit, to prevent the overflow of water.

The key features of the device are: having both a water alarm and temperature monitor within one unit and temperature display on the LCD screen that alerts the user if the water is too hot.

Price range: \$16 - \$17



26. Walk-in bathtub

Walk-in bathtubs offer a swing-in door that allows the user to walk in and out of the bathtub with ease. Some of the walk-in bathtubs also have a seating feature. The swing-in door can either be on the left or right side of the bathtub depending on the orientation of the bathroom. The bathtub shown in the picture has a non-slip bottom surface with arm support inside the tub, and an optional whirlpool system. (Note: Be careful of the elevated step height before getting in or out of the bathtub).

Price range: \$1570 - \$6548

Staircases and Laundry Room/Basement



27. Stairs grab bar

Specially designed grab bars can be installed on the walls alongside the stairs. The key feature of the grab bar shown is that its curved design allows for continuous support around the corner of the stairs.

Price range: \$57 - \$166



28. Stair railing with a good grip

Stair railings are available in a wide variety of designs, styles and materials. They provide support while climbing or descending the stairs inside the home. They can be made of wood, iron, steel, or vinyl. The design that allows for a good grip, as shown in the picture is highly recommended instead of handrails that are too fat or wide to comfortably grip.

Price range: \$150 - \$200 for 8 foot section
\$300 - \$360 for 10 foot section



29. Stair treads

Stair treads prevent accidental slips while ascending or descending the stairs. They are available in various colors and shapes. The stair treads shown in the picture have skid-resistant rubber backing. These stair treads attach to the surface of the stairs by “hook-and-loop” fastening strips (Velcro). The “hook” strip is sewn into the stair tread and the “loop” strip is glued to the stairs. These strips are used to attach and detach the stair tread when needed.

Price range: \$56 - \$387 for a pack of 12 - 13 pieces.



30. Stairs LED lighting kit

When installed on stairs, the motion activated LED lights illuminate the areas that need additional lighting. The light shown in the picture is battery powered and comes with universal (interchangeable) joints that are easy to install.

Price range: \$50 – \$127

Personal Emergency Response System and Fall Detecting Device



31. Fall detection system

Personal emergency response systems (PERS) detect falls and alert the caregivers, emergency response call center, or 911 for a monthly fee. These devices use internet or phone lines to send out the alert. The key features of this device are as follows: Tracking the daily activities of a user on a website, automatic fall detection and alert message to family members, automatic reminders if not worn, can be used with a compatible cell phone to send alert and fall location.

Price range: \$100 - \$400

Total Number of Home Hazards

Transfer all the total scores of each room/ area from pages 4-21 to the appropriate boxes and add all the scores to get a grand total. Three blocks for each area are provided for you to keep records of your assessments and improvements for three occasions.

| | | | |
|--|---|---|---|
| Date | _____ | _____ | _____ |
| Entrance to Front Door and Front Yard | <input style="width: 50px; height: 25px;" type="text"/> | <input style="width: 50px; height: 25px;" type="text"/> | <input style="width: 50px; height: 25px;" type="text"/> |
| Entrance to Back/Side Door | <input style="width: 50px; height: 25px;" type="text"/> | <input style="width: 50px; height: 25px;" type="text"/> | <input style="width: 50px; height: 25px;" type="text"/> |
| Hallway or Foyer | <input style="width: 50px; height: 25px;" type="text"/> | <input style="width: 50px; height: 25px;" type="text"/> | <input style="width: 50px; height: 25px;" type="text"/> |
| Living Room | <input style="width: 50px; height: 25px;" type="text"/> | <input style="width: 50px; height: 25px;" type="text"/> | <input style="width: 50px; height: 25px;" type="text"/> |
| Kitchen | <input style="width: 50px; height: 25px;" type="text"/> | <input style="width: 50px; height: 25px;" type="text"/> | <input style="width: 50px; height: 25px;" type="text"/> |
| Bedroom | <input style="width: 50px; height: 25px;" type="text"/> | <input style="width: 50px; height: 25px;" type="text"/> | <input style="width: 50px; height: 25px;" type="text"/> |
| Bathroom | <input style="width: 50px; height: 25px;" type="text"/> | <input style="width: 50px; height: 25px;" type="text"/> | <input style="width: 50px; height: 25px;" type="text"/> |
| Staircases | <input style="width: 50px; height: 25px;" type="text"/> | <input style="width: 50px; height: 25px;" type="text"/> | <input style="width: 50px; height: 25px;" type="text"/> |
| Laundry Room/Basement | <input style="width: 50px; height: 25px;" type="text"/> | <input style="width: 50px; height: 25px;" type="text"/> | <input style="width: 50px; height: 25px;" type="text"/> |
| Grand Total | <input style="width: 50px; height: 25px;" type="text"/> | <input style="width: 50px; height: 25px;" type="text"/> | <input style="width: 50px; height: 25px;" type="text"/> |

To fix problems at home, you can contact the listed home modification service providers found on pages 35 and 36. To obtain free services for home modification, refer to pages 37 and 38. To record your home modification improvement use action log on page 46 and 47.

Picture Credits for Assistive Devices and Helpful Products (as of September, 2013)

1. Vinyl and resin railing: <http://www.thevinyloutlet.com/railgallery.html>
2. Rubber threshold ramp: <http://www.allegromedical.com/wheelchair-accessories-c545/ez-access-rubber-threshold-ramp-with-beveled-sides-p555797.html>
3. Motion sensing security lamp: http://www.homedepot.com/h_d1/N-25ecodZ5yc1v/R-100125618/h_d2/ProductDisplay?catalogId=10053&langId=-1&keyword=motion+light&storeId=10051&superSkuld=202573742#.UO2Hqm9EHuM
4. Suitcase ramp for mobility devices: <http://www.allegromedical.com/travel-aids-c6857/ez-access-suitcase-ramps-advantage-series-2-3-4-5-and-6-ft-lengths-p555734.html>
5. Cane icetip: http://www.amazon.com/Duro-Med-Prong-Grip-Crutch-Attachment/dp/B0009STN2E/ref=sr_1_2?ie=UTF8&qid=1357744185&sr=8-2&keywords=cane+ice+tip
6. Outdoor grab bar: <http://www.amazon.com/Prima-Grab-Bar-Outdoor-Green/dp/B0051BFLKC>
7. Motion sensing LED light: <http://www.coolstuffcheap.com/mb723.html>
8. Rug pad: http://www.walmart.com/ip/Eco-Grip-Rug-Saver-Pad/10963059?sourceid=1500000000000003260370&ci_src=14110944&ci_sku=10963059
9. Single-piece cable cover: : http://www.homedepot.com/h_d1/N-25ecodZ5yc1v/R-202331941/h_d2/ProductDisplay?catalogId=10053&langId=-1&keyword=single+piece+cable+cover&storeId=10051#.UO2Jfm9EHuM
10. Furniture Risers: http://www.amazon.com/Clear-Bed-Risers-Set/dp/B000L3QBEK/ref=pd_cp_e_0
11. Standing cane with tray feature: http://www.amazon.com/Standers-2052-Able-Tray/dp/B0026IBSUA/ref=pd_sim_sbs_hpc_2
12. Three step ladder: http://www.amazon.com/Werner-StepRight-225-Pound-Rating-3-foot/dp/B000IZU3H2/ref=sr_1_3?ie=UTF8&qid=1357744754&sr=8-3&keywords=three+step+ladder+rubbermaid
13. Non-slip Socks: <http://www.silverts.com/show.cfm/image/19140-non-skidslip-sockshospital-socks/pink>
14. Lazy Susan: http://www.amazon.com/Rev-A-Shelf-3072-18-11-52-Value-Circle-Susan/dp/B002QBW4C8/ref=lp_3744181_1_24?s=kitchen&ie=UTF8&qid=1382363928&sr=1-24
15. Tall security gate: Courtesy of Karen Barnes.
16. Programmable stove shutdown device: <http://www.thiscaringhome.org/products/auto-stove-shut-off.php>

17. Carpet trim: : http://www.homedepot.com/Flooring-Carpet-Carpet-Tile-Carpet-Tools-Accessories/h_d1/N-5yc1vZbng9/R-100198103/h_d2/ProductDisplay?catalogId=10053&langId=-1&storeId=10051#.UO2NR29EEwA
18. DECT 6.0 cordless phone: <http://shop.clarityproducts.com/products/clarity/d703/?cat=amplified-cordless-phones>
19. Big button remote control: <http://www.amazon.com/Tek-Pal-Button-Remote-Control/dp/B0016RNSHS>
20. Bedside cane: http://www.amazon.com/Standers-2041-BedCane/dp/B000GUHG6K/ref=sr_1_1?ie=UTF8&s=hpc&qid=1294338253&sr=8-1-catcorr
21. Bathtub grab bar: http://www.amazon.com/Drive-Adjustable-Clamp--Tub-Rail/dp/B001BLTI96/ref=sr_1_4?ie=UTF8&qid=1294349836&sr=8-4
22. Right angled grab bar: <http://www.shopinpro.com/store/product/tabid/60/p-182-l-shaped-grab-bar.aspx?catid=161>
23. Raised toilet seat: http://www.amazon.com/Tall-Ette-725881000-Extra-Elevated-Toilet/dp/B000AYG7ZS/ref=sr_1_8?s=hpc&ie=UTF8&qid=1294348063&sr=1-8
24. Bath mat: http://www.amazon.com/Rubbermaid-18x36-Brown-Bath-Mat/dp/B000VBC1SC/ref=cm_cr_pr_product_top
25. Water alarm with temperature monitor: <http://www.amazon.com/Starfish-Warter-Alarm-Temperature-Monitor/dp/B000V22BKY>
26. Walk-in bathtub: <http://www.ameriglide.com/item/AmeriGlide-Sanctuary-Full.html>
27. Stairs grab bar: <http://www.grabbarspecialists.com/products.php?cat=591>
28. Stair railing with a good grip: <http://www.vandykes.com/victorian-wooden-handrail/p/208415/>
29. Stair treads: http://www.amazon.com/12-Attachable-Carpet-Stair-Treads/dp/B0040UIP0I/ref=pd_sbs_misc_15
30. Stairs LED lighting kit: <http://ecobatteries.net/Motion-Sensor-Stair-and-Hallway-LED/M/B0020MLFQO.htm>
31. Fall detection system: <http://www.ubergizmo.com/2010/01/wellcore-stylish-mobile-personal-emergency-response-system/>

“ HOW TO ” HOME IMPROVEMENT INSTRUCTIONS (Steps to make changes and before and after photos)

Entrance to Front and Back of House

1. Outdoor Grab Bar

To install a weatherproof grab bar into a brick wall:

1. Locate grab bar at the needed height as well as making it plumb (in alignment) with level.
2. Mark the wall where the holes need to be drilled for mounting.
3. With a cordless drill and masonry drill bit, drill holes as marked.
4. Using masonry screws attach the grab bar to the wall.
5. Install grab bar covers. (See pages 23 and 31)

Tools needed: Cordless drill, masonry bit, level, pencil, masonry screws and 1/4 “ driver for screws.



Before



After

2. Wireless Doorbell

To install a wireless doorbell:

1. Plug in wireless chime in outlet inside your home.
2. While standing at the door, push the doorbell button to check range before mounting.
3. Mount doorbell buttons on either front door frame or side door frame or both.
 - A. Remove the back of the push button case by pushing in tab on bottom with a small screwdriver.
 - B. Place the back of the push button onto the door frame in the desired location.
 - C. With a cordless drill, secure each screw.
 - D. Snap front of push button onto the back.

Tools needed: Cordless drill, drill bits and Phillips screwdriver.

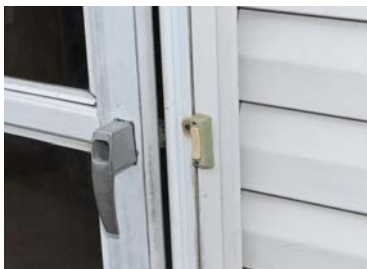

Before



Wireless chime

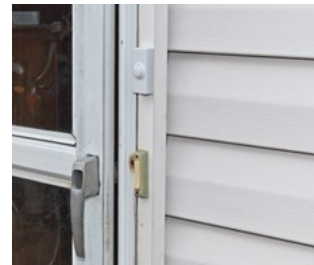

After

3. Door Mounted Mail Catcher

The cardboard, broom, papers, and plastic bags on the floor create a slippery and cluttered surface that can lead to a fall. The mail slot does not have a catcher, therefore adding to the cluttered area. By simply placing a mail catcher (Snail Sakk) against the slot, it will prevent papers and mail from being scattered on the floor and also eliminate the draft. The mail catcher is a heavy duty fabric that attaches to the front door. It is easy to install and durable.

To install:

1. Peel the plastic off of one adhesive interlocking strip, which is included in the product.
2. The two strips of interlocking nylon, like Velcro, should be placed 3.75 inches apart.
3. Place the first strip horizontal, slightly above the mail slot.
4. The second strip is placed horizontally below the mail slot.
5. Attach the interlocking nylon strip on the fabric to the matching interlocking nylon strip on the door.
6. This mail catcher comes with a mini ruler that doubles as a mail opener and magnifier.
7. To retrieve your mail you can slide your mail through the side slots or pull down the top corner of the fabric.

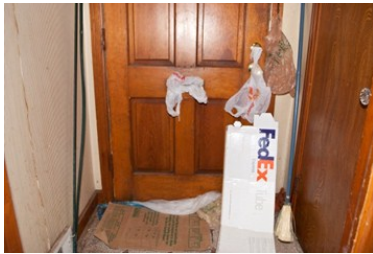

Before



After

Hallway and Living Room

4. Lighting using X10 product (X10 is a name of smart home products)

To provide lighting throughout the house, X10 motion sensor lights can be installed to automatically turn on and off lights when walking room to room. In addition, lights can be turned on and off using a remote control, as described below.

To install the X10 remote controlled light:

1. Set the code on the transmitter. (e.g.1A).
2. Set the remote control to the same code as the transmitter (1A).
3. Plug the lamp into the bottom of the transmitter.
4. Plug the transmitter into the wall outlet.
5. Turn the light on.
6. Use the remote control to turn on/off the lights.



X10 device

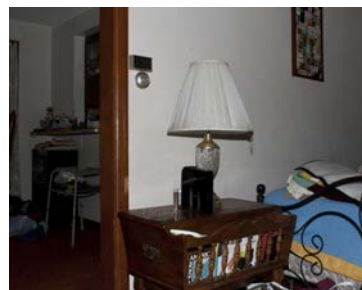

After

5. Light Switches

It is a safety hazard when there is no cover on a light switch. Placing a cover over the switch is an inexpensive fix. Depending on the type of switch installed, single, double or triple toggle switch covers are available. The size of the switch plate can vary as well. A standard size switch plate is used in this house, but if the switch outlet needs to cover a larger wall area, jumbo size switch plates are available.

To install:

1. To replace a light switch cover, you will need a flat head screwdriver.
2. Most switch covers come with the screws you will need.
3. Line up the switch plate with the holes in the wall.



Before



After

6. Ceiling Fans

Proper lighting should be installed throughout the house. The picture below, on the left, has little or no lighting and is unsafe, with wires exposed. Checking the electrical wiring and replacing this fan with one that provides more light is recommended. The fan on the right has a large globe underneath providing adequate light. Many fans also come with dimmer switches to decrease or increase lighting. An electrician should install any ceiling fans for proper installation.



Before



After

7. Cable Cord

The cable cord in the middle of the room is a fall risk. There are two ways to fix this problem:

1. Purchasing a cable cover will secure the cable to the ground to prevent tripping over the cord.
2. Reroute the cable cord along the wall and over the door frame. (Preferred method)

To secure the cord:

1. Run the cord from the wall to the source.
2. The length of the cable cord will determine the number of cable clamps that are needed to secure the cable around the door and wall.
3. Individual clamps should be placed about a foot apart.
4. Start from the wall and apply the clamps over the cord by hammering the clamp into the wall.

Tools needed: Hammer and nail type cable clamps.



Before

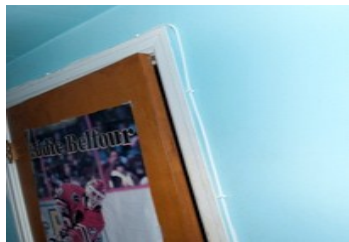

After

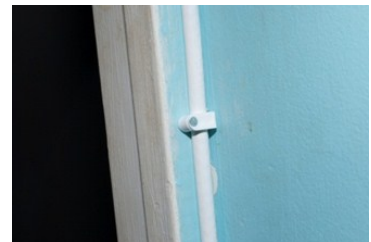

After

Kitchen

8. Step Ladder with a Tray

The wooden step ladder, in the left picture below, has a small standing platform and is unstable. The new, metal step ladder on the right is taller and includes a long handle bar to provide support when reaching for items up high. It also has a fold out tray and non-slip rubber steps to secure footing on the ladder.

To use the step ladder correctly:

1. Fully open ladder and place on a level surface.
2. Place items on the ladder tray before stepping on to it.
3. Hold the handle with both hands when stepping on or off the ladder.
4. When placing an item on or off a shelf, remember to always hold onto the handle with one hand.

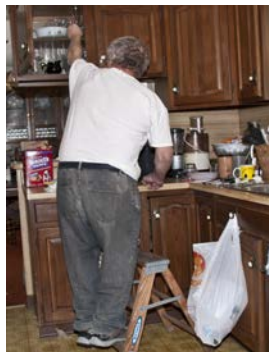

Before



After

Staircase and Basement

9. Non-slip Steps

The poor lighting makes it difficult for an individual to notice where each stair ends, therefore causing a fall hazard. Using a non-slip tape to make a contrast line on the edge of each step will better define the staircase.

To apply the tape:

1. The tape used should be skid guard, safety tape about 2 inches thick.
2. Measure the length of one step and cut the tape to that length.
3. Before applying the tape, make sure the surface is completely clean and dry.
4. Lift one end of the strip and peel back the first 2 inches of the backing.
5. Press the tape firmly onto the step starting at one end.
6. Lift the strip from the other end and peel off the next few inches of the backing.
7. Press the tape down firmly until you have applied the entire strip to the stair.
8. Repeat for each step.

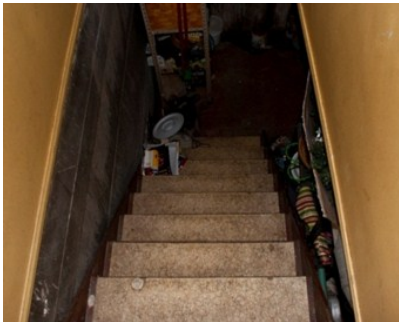

Before

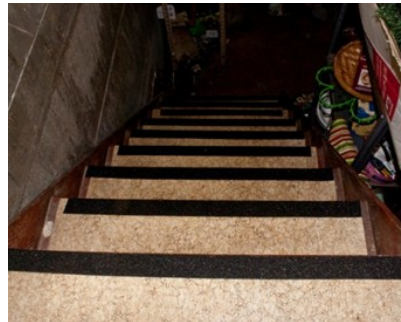

After

10. Contrast Floor

The basement floor color should be in contrast to the staircase (e.g. brown and blue). This allows a person to know that there are no more steps to be taken.

To Paint the Basement Floor:

1. Outline the area you are going to paint with tape.
2. With a paintbrush fill in the middle area of the tape with the paint.
3. Let the paint completely dry before removing the surrounding tape.



Before



After

11. Installing a Railing

Staircases should have a railing installed to provide support when ascending or descending the stairs.

To install hand railing:

1. Using a cordless drill, secure two support posts, 2in x4in x7ft, to the bottom step and the basement ceiling, if necessary.
2. Mark where each handrail bracket will be placed on the wall and on the support posts with a pencil, ruler and a level.
3. Screw in each bracket to the wall and support post.
4. Attach the 10 foot handrail to the brackets on the wall with a screwdriver.
5. Repeat steps 2-4 for the 44 inch handrail on the landing area.

Tools needed: Handrail, brackets, cordless drill, 6' tape measure, ruler, screws, level.



Before



After



After

12. Fixing a Railing

All homes should have a railing that is correctly positioned and securely fastened to the wall for support when ascending and descending any staircase.

To repair:

1. Remove current support brackets from the wall using a screw driver.
2. Clean out all of the loose plaster.
3. Mix up repair plaster material in a mixing container.
4. Fill the hole with the repair mix using a putty knife to level with the wall.
5. When completely dry reinstalled bracket with new screws.

Tools and materials needed: Phillips screwdriver, brush, cordless drill, drill bits, screws, putty knife, mixing container and plaster repair material.

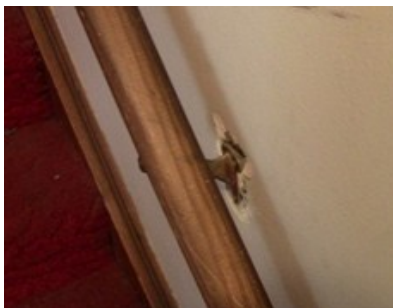

Before



After

13. Grab Bars

Adding grab bars in different locations throughout the house provides support when needed. Securing two grab bars on both sides of the door in the picture below will provide stability for the individual when opening the door, and going up and down the stairs.

To install grab bars:

1. Locate where the grab bar will be placed on the wall with both ends of the bar over a wall stud. Using a pencil, mark on the wall the location of the screw holes in the ends of the grab bar.
2. Use a level to correctly place the grab bar.
3. Using a cordless screw driver, drill the screws that came with the grab bar through the holes in the grab bar and into the wall so that the heads of the screws are flush with the mounting plate on the grab bar.

Tools needed: Small level, cordless drill, drill bits and screw shields, if needed.



Before



After

14. Loose Wires

The wires, in the picture on the left, should be mounted to the ceiling. To secure the cable/wires to the ceiling, a wire staple or clamps are used (Picture below).

To secure the wire,

1. Use a wire stapler, clamps or a wire tie to secure the cord to the ceiling.
2. Staples or clamps should be 12 inches apart.

Tools needed: Wire stapler or hammer and nail type cable clamps.



Before



After

15. Basement Door

The old bi-fold door was not repairable. A new bi-fold door was installed.

To Install:

1. Remove door and all old hardware.
2. Install new hardware from door assembly as per instructions.
3. Place door in opening and make adjustments as needed.

Visit the website for detailed instruction: <http://www.diynetwork.com/windows-walls-and-doors/how-to-install-bifold-closet-doors/pictures/index.html>

Tools needed: Phillips screwdriver, cordless drill.



Before



After

Clutter

16. Clutter

The clutter in this room blocks walking paths and makes it a fall hazard. Eliminating clutter such as clothes, paper and baskets from the shelves and floor decrease the risk of falling.

Helpful tips:

1. Sort clothing into piles you would like to keep or toss out.
2. Place clothing into dresser and/or closet. Remove items from floor and place onto shelves.
3. Toss all unnecessary papers.
4. Place papers and small items into a filing cabinet and organizers.

Particular instruction may not be needed to remove clutter. The most difficult part is to keep the room clutter-free. A suggested way is to organize a room functionally and practically, e.g. using a filing cabinet. Make a habit of putting things away when you are finished using them. Habits are hard to change but are important for safety. For 25 steps on how to reduce clutter, visit <http://www.casedesign.com/blog/home-remodeling/25-steps-on-how-to-remove-clutter>

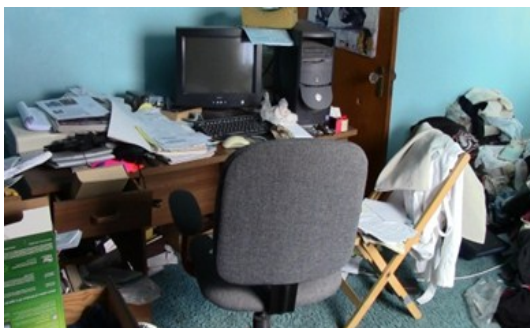

Before



After

Tips for Fall Prevention

- 1. Provide seating at the entrance to the home, so that a person can rest or put down things in their hand.**
- 2. Small icicles that are within easy reach should be removed so that entry to and exit from the home are safe. Do not try to remove bigger and dangerous icicles by yourself. Instead have them removed by someone else.**
- 3. Always wear shoes that fit properly and have nonskid soles with Velcro fasteners instead of laces.**
- 4. Install light switches at the top and bottom of all stairs.**
- 5. Use lights with high wattage bulbs to see more clearly.**
- 6. Installation of automatic lighting in areas of frequent activity can aid in safer night activity.**
- 7. Keep emergency flashlights near the bed to help locate the light switches and provide illumination in case of a power outage.**
- 8. When climbing or descending stairs, you should never be in a hurry to pick up a phone. It can wait!**
- 9. Remember the number of stairs and count each step when climbing or descending.**
- 10. While carrying things, always keep one hand empty so that it is possible to grab on to something in case support is needed.**
- 11. Electrical and phone cords should be removed from walkways to reduce the risk of falls.**
- 12. Regularly used items in the kitchen should be placed where they are easily accessible.**
- 13. When using a ladder, always keep three points of contact with the ladder, that is two feet and one hand.**
- 14. The use of a handheld shower makes it safer and easier to take a shower.**
- 15. The size and contents of a laundry basket should not be too heavy. Use a small basket for comfortable use.**
- 16. For emergency purposes there should be a phone in the bathroom, attic, and laundry room.**
- 17. For emergency purposes, keep a bag with a 3-day supply of water and food, contact list, radio, flashlight, first aid, medications, etc. placed near the exit of the house.**

Home Improvement Centers and Durable Medical Equipment Providers in Erie County

The following durable medical equipment providers in Erie county were selected from the medical suppliers listing in the yellow pages.

| <u>NAME AND ADDRESS</u> | <u>TELEPHONE NUMBER E-MAIL ADDRESS</u> |
|---|---|
| Home Improvement Centers | |
| The Home Depot Amherst, Buffalo, Cheektowaga, West Seneca, Williamsville | 1(800)-466-3337 www.homedepot.com |
| Lowe's E. Amherst, W. Amherst, Hamburg, Orchard Park | 1(800)-445-6937 www.lowes.com |
| Valu Home Center Amherst, Buffalo, Cheektowaga, Depew, Lackawanna, Orchard Park, Tonawanda, Williamsville | www.valuhomecenters.com |
| Durable Medical Equipment Providers | |
| Sheridan Surgical 4513 Bailey Avenue, Amherst , NY 14226 | 716-836-8780 www.sheridansurgical.com |
| Cleve-Hill Home Health Care 1479 Kensington Ave, Buffalo , NY 14215 | 716-832-7744 http://www.buffalopharmacies.com |
| Dove Medical 4114 Union Road, Cheektowaga , NY 14225-3406 | 716-688-8911 http://www.blackburnsmed.com/ |
| Reliant Medical Equipment & Supply 2375 Union Road, Cheektowaga , NY 14227 | 716-809-1621 www.reliantmedicalequipment.com |
| Transit Hill Pharmacy 6344 Transit Road, Depew , NY 14043-1095 | 716-683-9444 http://transithillpharmacy.com/ |
| Benson's Surgical Supply 1025 Kenmore Ave, Kenmore , NY 14217 | 716-332-0404 www.bensonsurgical.com |
| Mobility Plus 1674 Abbot Road, Lackawanna , NY 14218 | 716-824-2243 www.mobilitypluswny.com |
| Snyder Health Mart Pharmacy 4536 Main Street, Snyder , NY 14226 | 716-839-3050 |
| Buffalo Wheelchair 1900 Ridge Road, West Seneca , NY 14224 | 716-675-6500 www.buffalowheelchair.com |
| Union Medical Pharmacy 1769 Orchard Park, West Seneca , NY 14224 | 716-675-4133 |

Home Modification Service Providers in Erie County

The following service providers were selected from among those who responded to our request to reply to create this list. They are insured, have experience in residential home modification to prevent falls, are willing to do a job under \$1,000. They have completed the workshop offered by us regarding the Americans with Disabilities Act and issues related to home modifications for fall prevention.

| <u>NAME AND ADDRESS</u> | <u>TELEPHONE NUMBER</u> <u>EMAIL ADDRESS</u> |
|--|--|
| Home Accessibility Construction 16 Canterbury Ct, Amherst NY 14226 Specializes in grab bars, railings, shower equipment | 716-833-3220 Ext 1 |
| Dennis Voytovich, Acemen Services, 11 Vincent Ave, Buffalo , NY 14225 Specializes in grab bars, railings, shower equipment | 716-472-6094 |
| Empire Renovations, 220 Wendel Ave, Buffalo , NY 14223 Specializes in full service and general contracting | 716-573-2006 716-693-5251 www.empirerenovations.com |
| Surianello General Concrete Contractors Inc. 635 Wyoming Ave, Buffalo , NY 14215 Specializes in full service and general contracting | 716-837-7710 surianello@aol.com |
| Munro Products, 9150 Clarence Center Road, Clarence Center , NY 14032 Specializes in full service and general contracting | 716-741-9450 www.munroproducts.com |
| Nolon General Contracting, 6769 Tuscany Lane, East Amherst , NY 14051 Specializes in full service and general contracting | 716-741-8167 www.NolonContracting.com |

| | |
|--|---|
| <p>Dodge Enterprises LLC., 136 Elm St, East Aurora, NY 14052 Specializes in full service and general contracting</p> | <p>716-652-4910 652-4961 (Fax) www.dodgeenterprises.com</p> |
| <p>Richard Lent Lent Builders Inc. 2416 White Haven Rd, Grand Island, NY 14072 Specializes in full service and general contracting</p> | <p>716-876-7816 www.lentbuilders.com</p> |
| <p>Burke Homes 5540 Southwestern Blvd # B, Hamburg, NY 14075 Specializes in full service and general contracting</p> | <p>716 646-0047</p> |
| <p>David J. Palmeri, Palmeri Builders Inc. 79 Victoria Blvd, Kenmore, NY 14217 Specializes in full service and general contracting</p> | <p>716-873-5418 (Off.) 716-602-8694 (Mob.)</p> |
| <p>Skubis brothers Construction, 12 Parkside Drive, Lancaster, NY 14086 Specializes in full service and general contracting and concrete work</p> | <p>716-683-7232 716-432-6263</p> |
| <p>Michael Tucker Sharp General Contracting Inc. CAPS provider 558 Oliver St, North Tonawanda, NY 14120 Specializes in full service and general contracting</p> | <p>716-743-2050 www.sharpgeneralcontracting.com</p> |
| <p>Lakestone Development Inc., 17 Limestone Rd #2, Williamsville, NY 14221 Specializes in full service and general contracting</p> | <p>716-631-1905</p> |

Organizations That Provide Free Services

Center for Assistive Technology (CAT) Client Service

CAT provides equipment on loan (free of charge) to individuals who can't afford to buy their own. They loan out equipment for about 6 to 8 weeks (that is the usual length of time).

Address: WNY Independent Living, Inc. 3108 Main Street, Buffalo, NY 14214

Contact person: Kimberly S. Naus

Phone: 716-836-1168

Email: kshaus@buffalo.edu

Website: <http://cat.buffalo.edu/>

Erie County Department of Senior Services

Erie County Senior Services helps people find the best care in the home. They provide funding for minor home repairs and assist with all sorts of other problems.

Address: 95 Franklin Street - Room #1329, Buffalo, NY 14202

Phone: 716-858-8526

Email: seniorinfo@erie.gov

Website: www.erie.gov/depts/seniorservices

Lions Blind & Charity Fund, Inc.

Lions Club provides assistive devices such as eyeglasses, hearing aids, etc. to citizens in their respective communities, and maintains loan closets for equipment such as wheelchairs and crutches.

Address: P.O. Box 2011, Buffalo, NY 14226

Phone: 716-694-4710

Website: <http://www.buffalolionsclub.org/>

Independence Foundation Loan Closet

Independence Foundation Loan Closet provides services for individuals and families with disabilities. Items that are provided include ramps, wheelchairs, hospital beds, etc. Individuals must arrange for personal pick up of the items.

Address: 2220 Hall Road, Elma, NY 14059.

Contact Person: Christine Muller

Phone: 716-685-3976

Website: www.theindependencefoundation.org

Hamburg Loan Closet (American Red Cross Hamburg Loan Closet)

Hamburg Loan Closet offers medical equipment to members of the community at no cost for a short period of time. The individual is responsible for pickup and return of equipment. This program is coordinated completely by Red Cross volunteers.

Address: 5161 Camp Road, Hamburg NY 14075

Contact Person: Ken Walker

Phone: 716-648-4400

Continued from page 37

Muscular Dystrophy Association (MDA) of WNY Loan Closet

MDA loan closets lend durable medical equipment to those unable to obtain prescribed equipment through alternate sources. Depending on availability, the loan closets offer, at no cost, hospital beds, patient lifts, wheelchairs, walkers, shower benches, transfer boards, communication devices and other durable medical equipment to those the Association serves with muscular dystrophy and related neuromuscular diseases.

Address: 500 Main Street # 343, Buffalo, NY 14221

Contact person: Johnita Hairston (Health Care Services Coordinator)

People Inc. Senior Services

The Access to Home program in People Inc., provides financial assistance with home modifications for seniors and individuals with disabilities in order to prevent movement into a nursing home or other types of assisted living centers.

Address: 1219 North Forest Road, P.O. Box 9033, Williamsville, New York 14231

Contact Person: Access to Home Coordinator

Phone: (716) 817-9000

Website: http://www.people-inc.org/community_outreach_home/access_to_home/index.html

Supportive Services Corporation

Supportive Services corporation is a private non-profit organization administrating Federal, State, and local grant. They provide weatherization assistance to income eligible Erie County residents outside the City of Buffalo.

Address: 245 Elmwood Avenue, Buffalo NY 14222

Contact Person: Daniel Wojcik

Phone: (716) 881-6350

Website: <http://www.supportiveservices.org/>

Legal Services for the Elderly, Disabled, or Disadvantaged of WNY (LSED)

LSED is a not-for-profit human service agency that provide specialized, free civil legal services to elderly people in the community of Western New York. They have a housing program through which they assist to obtain grant money to make a necessary repairs.

Address: 237 Main Street, Suite 1015, Buffalo, NY 14203-2717

Phone: (716) 853-3087 in Erie County

Website: <http://www.lsed.org/contact.php>

Neighborhood Legal Services, Inc.

Neighborhood Legal Services, Inc. is a non-profit agency that provides services to persons with low-income and/or disabilities. They enforce the Fair Housing Act to obtain assistive technology and provide services regarding housing.

Address: 237 Main Street, 4th floor, Buffalo, NY 14203

Phone: (716) 847-0650, TTY (716) 847-1322

Website: <http://www.nls.org/nlsbroch.htm>

Instruction for Home Modifications to Prevent Falls: ADA Guidelines

By Dean Carroll OTR/L

Americans with Disabilities Act of 1990 (ADA) established guidelines for wheelchair users and individuals with disabilities in the community. ADA guidelines are designed to meet the needs of the majority of users, no matter what their ability or disability level is. Although it does not specially apply to residential homes, it is important to keep the ADA guidelines in mind when modifying homes for an individual's need.

ADA guidelines have already been proven to be effective for most people. Many homes in Erie County were built prior to 1976 and before the current, more standardized building codes. Those homes were not built for wheelchair use, walker access, and older adults. For these homes, home modification may be necessary using ADA guidelines.

Most commonly needed modifications are:

- bathroom grab bars near the toilet and in the shower or the tub;
- railings on both sides of a stairway, if possible;
- widening of door frames for greater access to common areas such as bathrooms kitchens, and bedrooms; and
- repair and removal of structural barriers such as inadequate flooring, uneven transitions between flooring surface, and other non-structural barriers such as furniture.

Structural issues and barriers to meeting ADA guidelines are:

- limited floor space,
- limited wall space for installing grab bars,
- wall studs that are generally 16 inches on center,
- unknown barriers within walls, and
- financial limitations.

Common devices and features for consideration are:

- smooth versus textured grab bars,
- one stair railing versus two stair railings,
- height of grab bars in comparison to the user, and
- minimum width of door frames for walker and wheelchair access.

The following pages are figures for: toilet grab bars, shower access, grab bar spacing, wheelchair ramps, and wheelchair turning space from Department of Justice, Code of Federal Regulations, ADA Standards for Accessible Design and they are available from <http://www.ada.gov/adastd94.pdf>

Toilet Grab Bars

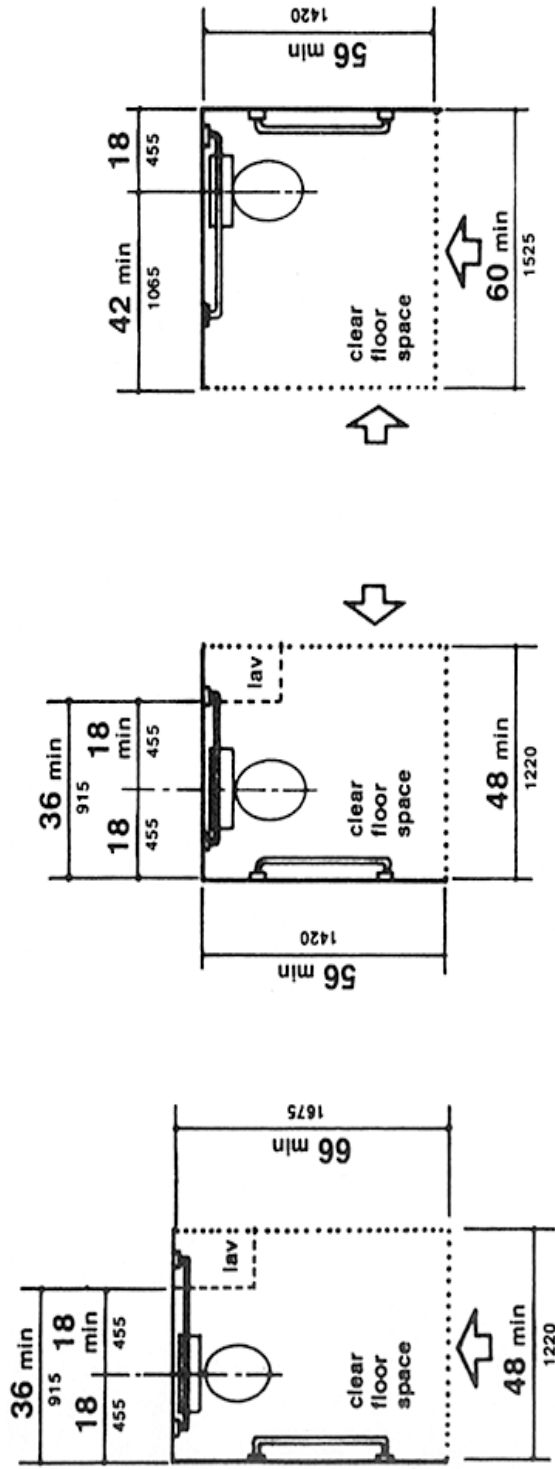
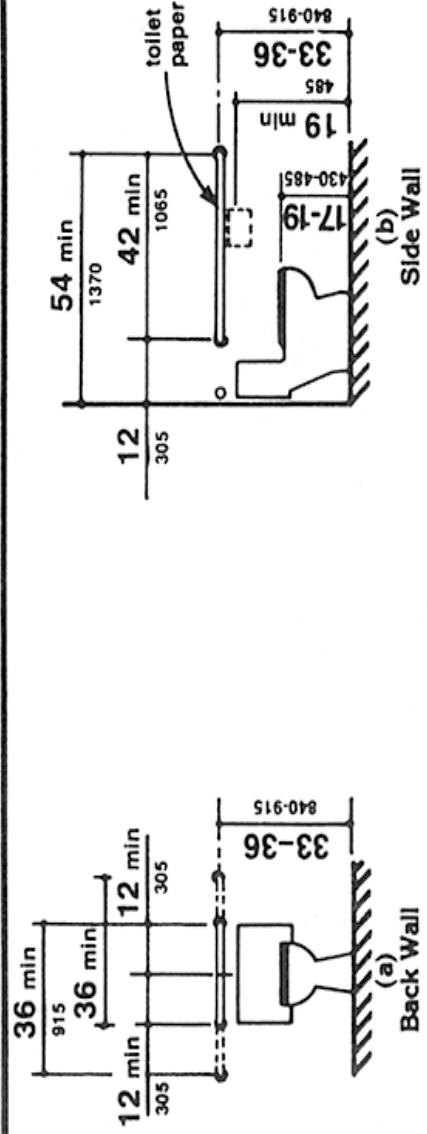

Fig. 28
Clear Floor Space at Water Closets



Shower Access

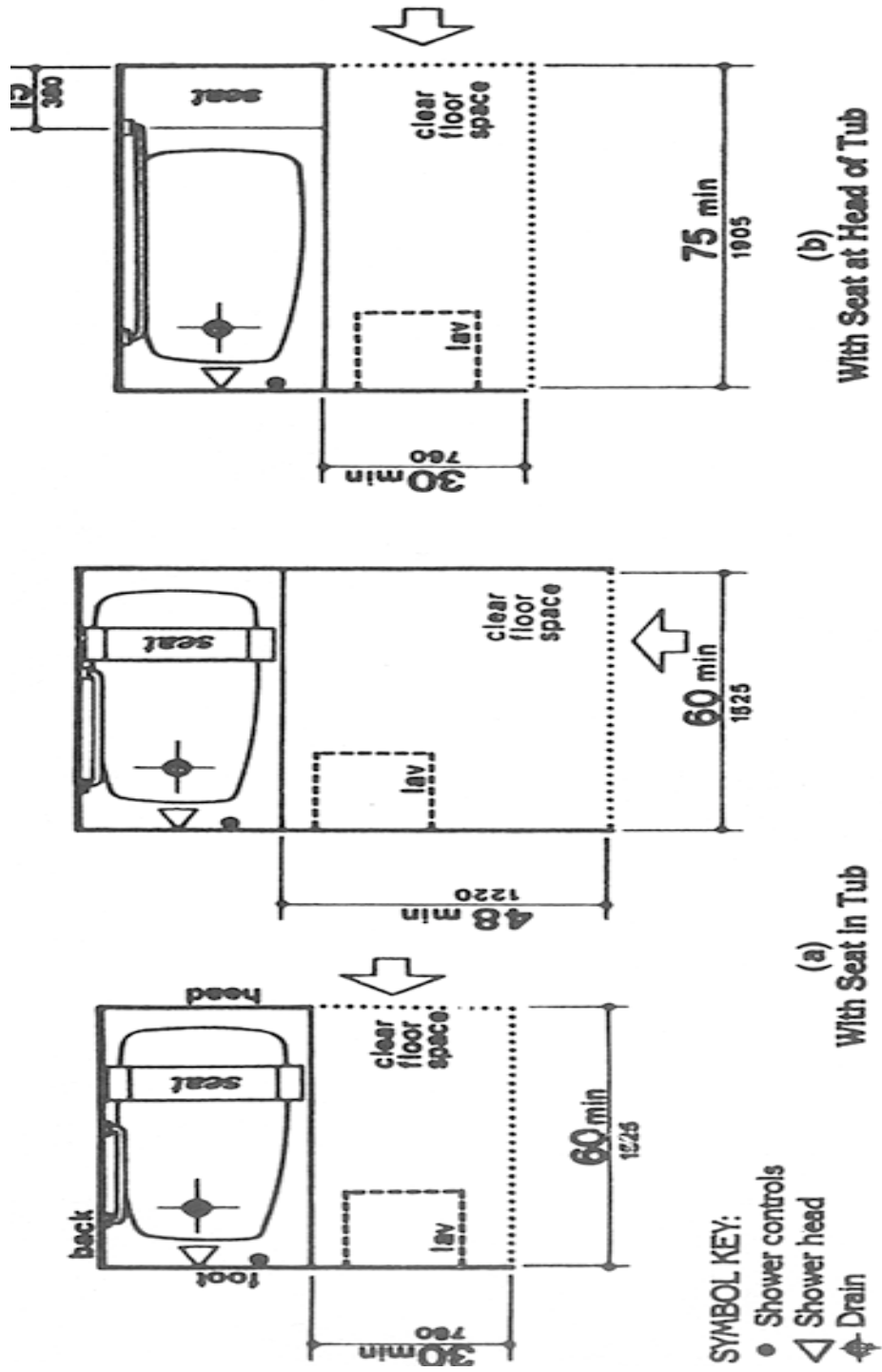
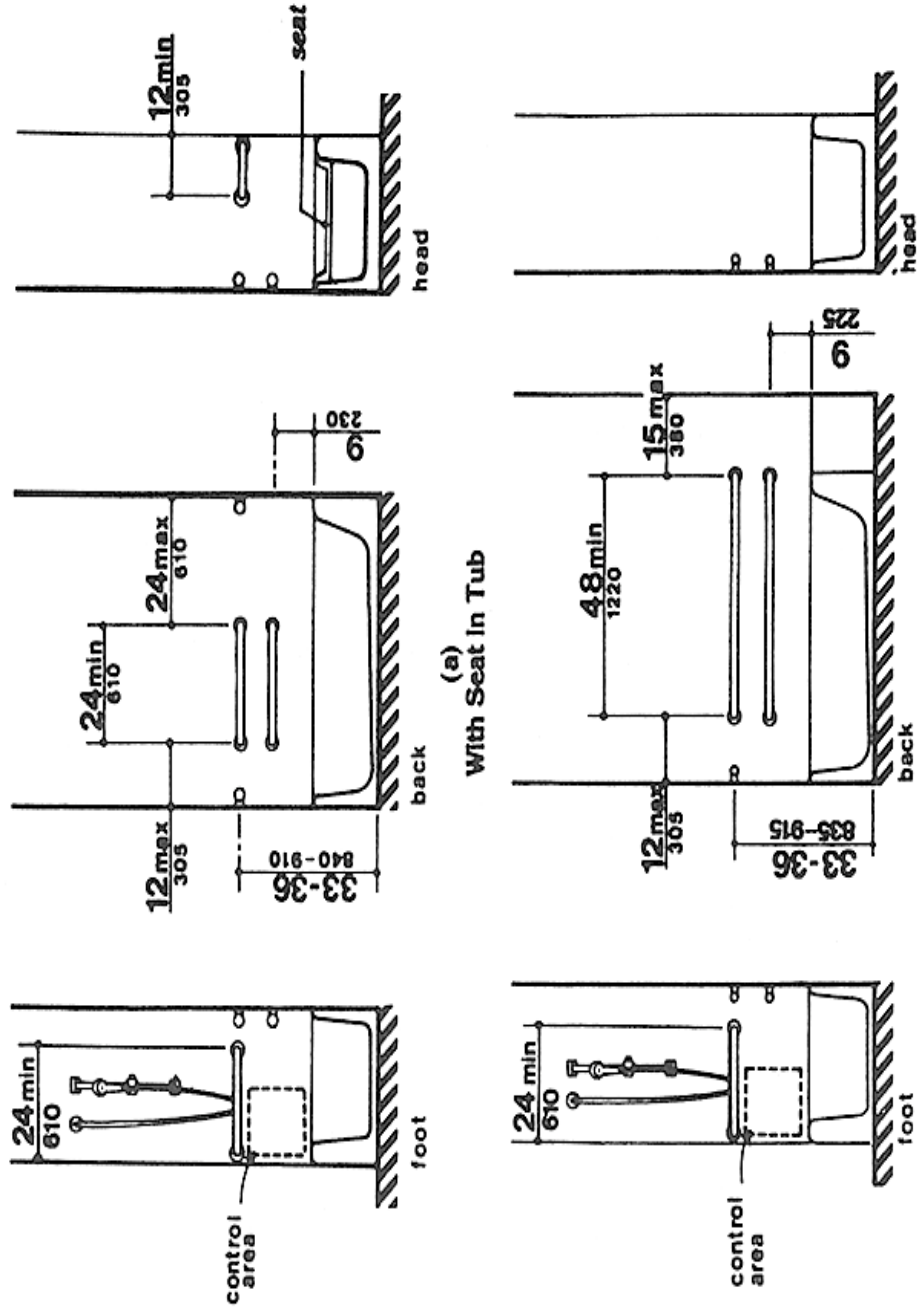

Fig. 33
Clear Floor Space at Bathtubs

Shower Access Continued



(a) With Seat In Tub
 (b) With Seat at Head of Tub
Fig. 34
Grab Bars at Bathtubs

Grab Bar Spacing

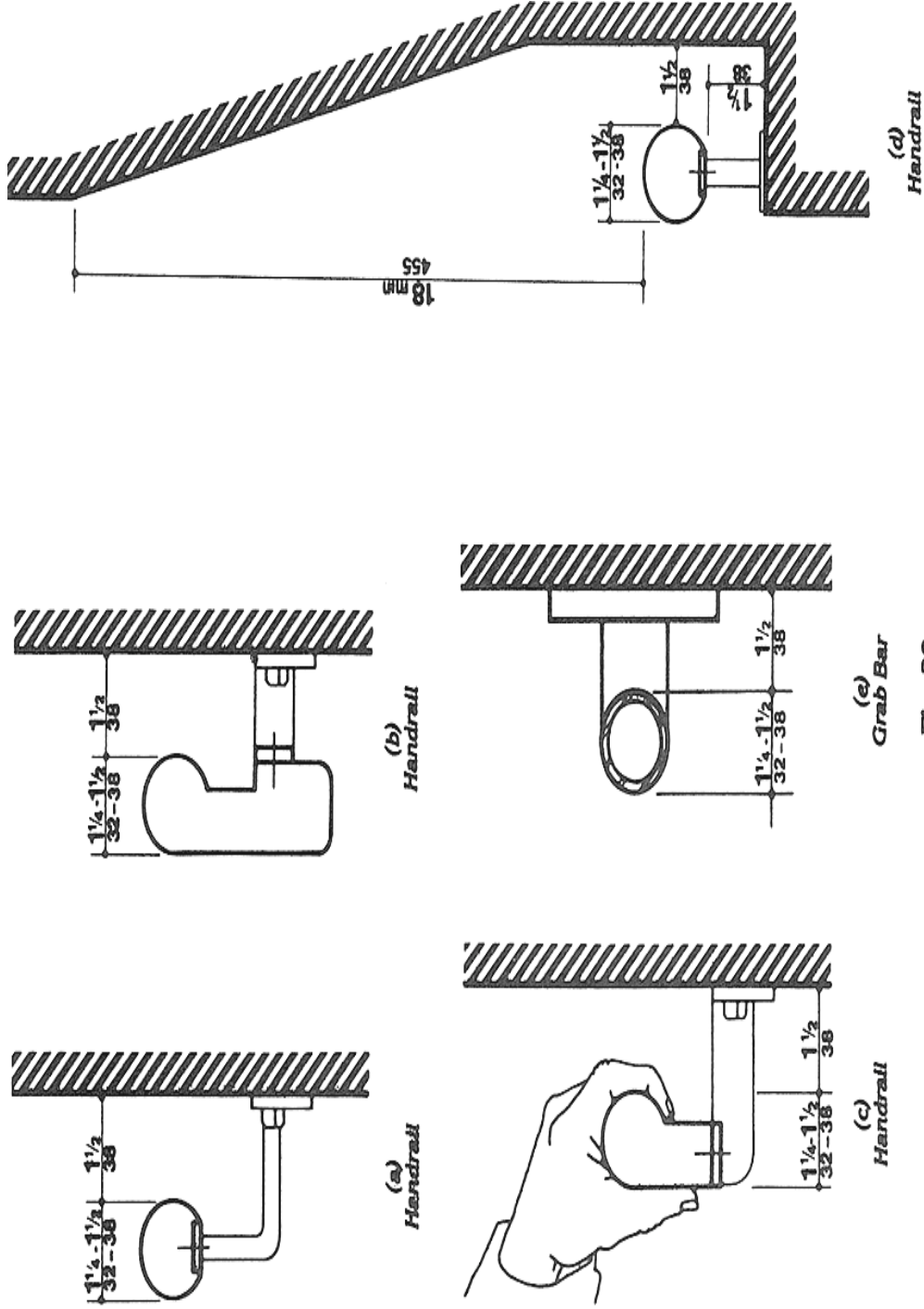
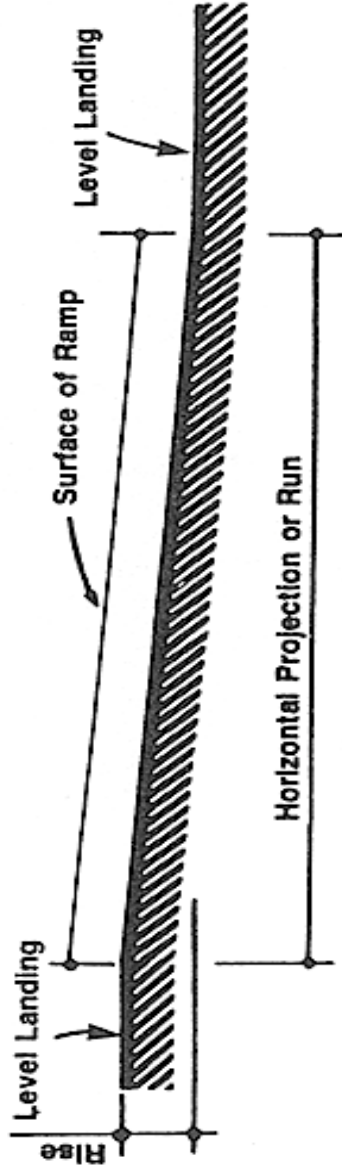

Fig. 39
Size and Spacing of Handrails and Grab Bars

Department of Justice, Code of Federal Regulations, ADA Standards for Accessible Design, 1994, p. 542

Wheelchair Ramps



| Maximum Rise | | Maximum Horizontal Projection | |
|----------------|----|-------------------------------|----|
| Slope | in | mm | ft |
| 1:12 to < 1:16 | 30 | 760 | 30 |
| 1:16 to < 1:20 | 30 | 760 | 40 |

Fig. 16
Components of a Single Ramp Run and Sample Ramp Dimensions

Wheelchair Turning Space

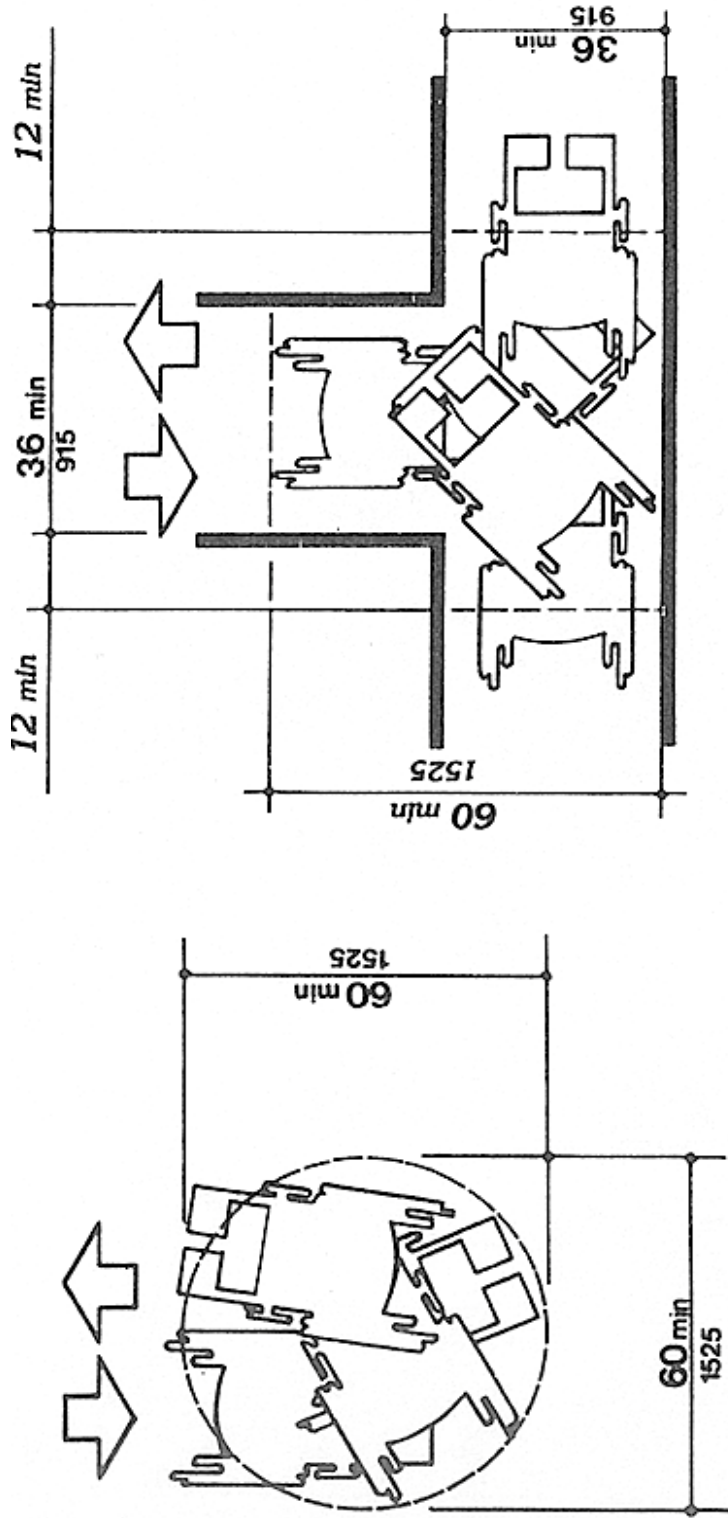

(a)
60-in (1525-mm)-Diameter Space

(b)
T-Shaped Space for 180° Turns

Fig. 3
Wheelchair Turning Space

Department of Justice, Code of Federal Regulations, ADA Standards for Accessible Design, 1994, p. 507

ACTION LOG:
ACTION TAKEN TO PREVENT FALLS AT MY HOME

| The Problem/Hazard: | I will do: | I have done: (mm/dd/yyyy) | Resources used/Cost |
|---------------------|------------|------------------------------|---------------------|
| <u>1.</u> | | | |
| <u>2.</u> | | | |
| <u>3.</u> | | | |
| <u>4.</u> | | | |
| <u>5.</u> | | | |
| <u>6.</u> | | | |
| <u>7.</u> | | | |

ACTION LOG:
ACTION TAKEN TO PREVENT FALLS AT MY HOME

| The Problem/Hazard: | I will do: | I have done: (mm/dd/yyyy) | Reduces used/cost |
|---------------------|------------|------------------------------|-------------------|
| <u>8.</u> | | | |
| <u>9.</u> | | | |
| <u>10.</u> | | | |
| <u>11.</u> | | | |
| <u>12.</u> | | | |
| <u>13.</u> | | | |
| <u>14.</u> | | | |

Acknowledgements

John A. Nyquist, MS, CMI
Board Certified Medical Illustrator
Office of the VP for Health Sciences, UB

Christine Oddo MS
Director, CAT Client Service
Center for Assistive Technology, UB

Dean J. Carroll, OTR/L

President, Home Accessibility Consultation

Linda S. Russ, Ph.D., OTR/L
D'Youville College

Jim Peron
Director, Design and Fabrication Shop
Center for Assistive Technology, UB

Nadine Fisher, Ed.D.
Department of Rehabilitation Science, UB

Rich Bogdan
Buffalo, NY

Derek Farkas
IT, School of Public Health and Health Profession
UB

Kathy Stanton, RN, MSN
Aging and Technology Research UB

OT Program Graduate Students

Sheela Rajendran, OTR/L, MS, Sumandeep Saharan, MS, OT, Emily Haggerty OTR/L, MS

OT Geriatric Group, Department of Rehabilitation Science, UB

Machiko R. Tomita, Ph.D.
Jo Schweitzer, MS, OTR/L,
Susan Nochajski, Ph.D., OTR/L

For download of this material, visit
www.agingresearch.buffalo.edu

**For questions, suggestions, and requests related to this material,
contact:**

Machiko R. Tomita, Ph.D.
Phone: (716) 829-6740
Email: machikot@buffalo.edu
Department of Rehabilitation Science
University at Buffalo
631 Kimball Tower
Buffalo, New York 14214

Acknowledgements

(In alphabetical order)

Autumnwood Senior Center

1800 Clinton St. Buffalo, NY 14206
(716) 826-7895

Erie County Department of Senior Services

95 Franklin Street, Room 1329, Buffalo, NY 14202
(716) 858-8526

http://www.erie.gov/depts/seniorservices/services_guide.asp

Gloria J. Parks Community Center

3242 Main Street, Buffalo, NY 14214
(716) 832-1010
<http://uhcda.org/web/>

Meals on Wheels for Western New York

100 James E Casey Drive, Buffalo, NY 14206
(716) 822-2002
<http://www.mealsonwheelswny.org/>

Millard Fillmore Suburban Hospital

1540 Maple Road, Williamsville, NY 14221
(716) 569-3600
<http://suburban.kaleidahealth.org/>

Network in Aging of Western New York

505 Kimball Tower, University at Buffalo
3435 Main Street, Buffalo, NY 14214
(716) 829-3712
<http://www.networkinaging.com/>

Parkside Community Association, Flint Hill Village Program

2318 Main Street, Buffalo, NY 14214
(716) 838-1240
<http://www.parksidebuffalo.org/>

Visiting Nursing Association of Western New York

2100 Wehrle Drive, Buffalo, NY 14221
(716) 630-8750
<http://www.vna-wny.org/index.asp>
seniorinfo@erie.gov